

FT-726R

OPERATING

MANUAL

YAESU MUSEN CO., LTD.

C.P.O. BOX 1500
TOKYO, JAPAN

FT-726R

ALL MODE TRIBANDER



GENERAL DESCRIPTION

The FT-726R is designed for the V/UHF amateur operator who requires every conceivable operating feature necessary for unlimited single and multi-band all mode operation with one convenient package. Interchangeable plug-in RF modules for each band allow the operator to install the bands of his choice. Each module provides 10 watts of RF output in all modes, and up to three modules can be installed at one time. Other modules can be installed or exchanged in a matter of minutes, and each includes a connector for controlling an external RF power amplifier.

A new degree of operating flexibility is made possible by a custom designed 8-bit NMOS microprocessor, coupled with a careful combination of front panel key buttons and controls that allows straightforward convenience even for the most exotic types of operation, such as reverse odd shift repeater testing or full duplex crossband splits for amateur satellite QSOs.

Special features are provided for each mode of operation, such as a discriminator center tuning meter and independent channel step tuning knob for FM, IF shift and width controls for CW and SSB, an AF SSB speech processor, and provision for an optional narrow CW filter. All modes can be tuned or scanned in 20 Hz steps, and both the tuning knobs and scanning system have selectable tuning rates.

All of the features that are considered extras on monoband transceivers are included, such as priority channel checking, programmable repeater shift, programmable limited band scanning, eleven memories storing both frequency and mode, memory scanning, and lithium memory backup retaining the memories, VFOs, programmed odd shift and clarifier offset.

In addition to the shift/width system, other functions previously unavailable except on HF transceivers include selectable AGC rates, RF gain control, fully independent multimode, multiband dual VFOs, and memory clarifier with separate display. Yaesu's unique dual multimeter system is included for expanded monitoring capability in both transmit and receive, or full duplex.

Options include the Satellite IF Unit, 600 Hz CW narrow filter, DC cable for 13.5V mobile or emergency operation, and a growing selection of RF modules for various bands.

Please study this manual carefully in order to become familiar with the many convenient features and capabilities of the FT-726R.

SPECIFICATIONS

GENERAL

Frequency coverage:

50 – 53.99998 MHz (option)
144 – 145.99998 MHz or
144 – 147.99998 MHz
430 – 439.99998 MHz (option)
440 – 449.99998 MHz (option)

Frequency steps:

20/200 Hz for SSB/CW/FM
5/10 kHz or 12.5/25 kHz for FM-CH mode
(per local requirements)

Repeater shifts:

±1 MHz for 50 MHz
±600 kHz for 144 MHz
±5 MHz, ±1.6 MHz or ±7.6 MHz for 430 MHz
(Programmable repeater shift also included)

Operating modes:

USB, LSB, CW, FM

Power requirements:

100, 110, 117, 200, 220, or 234 VAC
@ 50/60 Hz
or 13.8 VDC (w/optional cable)

Power consumption:

Receive: 45 VA (AC), 1.5 A (DC)
Transmit: 120 VA (AC),
4.5 A (DC) for 10 W RF

Dimensions:

334 (W) x 129 (H) x 315 (D) mm

Weight:

Approx. 11 kg
(w/o optional modules, Satellite Unit)

TRANSMITTER

Power input:

6 m : 20 W PEP/DC for 10 W out
2 m : 30 W PEP/DC for 10 W out
70 cm : 30 W PEP/DC for 10 W out

Carrier suppression:

Better than 40 dB

Spurious radiation:

Better than -60 dB

Unwanted sideband suppression:

Better than 40 dB

Transmitter audio response:

300–2,700 Hz at -6dB (SSB)

Maximum deviation:

±5 kHz (FM)

Modulation types:

A3J : Balanced modulator
F3 : Variable reactance modulator

Frequency stability:

6 m : Better than ±10 ppm
2 m : Better than ±10 ppm
70 cm : Better than ±5 ppm

Microphone impedance:

500–600 ohms

Tone call frequency:

1,800 Hz or 1,750 Hz
(per local requirements)

RECEIVER

Sensitivities:

6 m SSB : Less than 0.15 μ V for 10 dB
(S+N)/N
2 m SSB : Less than 0.15 μ V for 10 dB
(S+N)/N
70 cm SSB : Less than 0.15 μ V for 12 dB
(S+N)/N
6 m FM : Less than 0.25 μ V for 12 dB
SINAD
2 m FM : Less than 0.25 μ V for 12 dB
SINAD
70 cm FM : Less than 0.20 μ V for 12 dB
SINAD

(CW sensitivity is same as SSB if the optional
CW filter is not installed)

Selectivity (-6 dB/-60 dB):

SSB : 2.4 kHz/4.0 kHz (adjusts continuously
from 1.2 kHz to 2.4 kHz at -6 dB)
CW : 600 Hz/1.2 kHz
(with optional CW filter)
FM : 15 kHz/30 kHz

(CW selectivity is same as SSB if the optional
CW filter is not installed)

Image rejection:

Better than 60 dB

AF output:

1.5 W min. @ 8 ohms, 10% THD

AF output impedance:

4–16 ohms

IF frequencies:

10.810 MHz
10.750 MHz
455 kHz
67.615 MHz (70 cm units only)

Specifications subject to change without notice or obligation

ACCESSORIES

SUPPLIED

OPTIONS

AC Power Cord	1	50 MHz Unit For 50–54 MHz
T9013280 2 wire, 2 prong plug		(See model chart below)
T9013282 3 wire, 3 prong UL plug		430 MHz Unit For 430–440 MHz (")
T9013283 3 wire, 3 prong Australian plug		440 MHz Unit For 440–450 MHz (")
T9013284 3 wire, 2 prong EU plug		Satellite Unit For cross-band full duplex
Spare Fuse	1	(D3000236)
2A (Q0000003) 100–117 VAC		XF-455MC 600 Hz CW filter (D2000034)
1A (Q0000002) 200–234 VAC		FTS-32R* Tone squelch (32 selectable tones)
EXT Spkr plug C107	1	(D3000205)
(P0090034)		FTE-36* Tone encoder (31 selectable tones)
Dummy plug QS-P4F4	1	(D3000203)
(P1090042 jumpered Pin 1 to 3)		MD-1 _{B8} Desk-top microphone (D1000039)
Extender Foot 30A	2	MH-1 _{B8} Hand microphone (D1000040)
(R3054620)		SP-102 External speaker w/tone controls
Pad (R7054630A)	2	(A836001-Z)
144 MHz Band Module	1	DC cable For DC operation (D4000012)

* not available in U.S.

MODULE MODEL CHART

BAND MODULE	FREQUENCY COVERAGE	PRESET FREQUENCY	CHANNEL STEPS		REPEATER SHIFT	YAESU KIT NO.
			SSB CW	FM		
50 MHz UNIT (A)	50–53.99998 MHz	50.00000 MHz	20 Hz / 200 Hz	10 kHz / 5 kHz	± 1 MHz	D3000237
50 MHz UNIT (F)	50–53.99998 MHz	50.00000 MHz	20 Hz / 200 Hz	20 kHz / 10 kHz	± 1 MHz	D3000236
144 MHz UNIT (A1)	144–147.99998 MHz	147.00000 MHz	20 Hz / 200 Hz	10 kHz / 5 kHz	± 600 kHz	D3000243
144 MHz UNIT (A2)	143.5–148.49998 MHz	147.00000 MHz	20 Hz / 200 Hz	10 kHz / 5 kHz	± 600 kHz	D3000244
144 MHz UNIT (B)	144–145.99998 MHz	145.00000 MHz	20 Hz / 200 Hz	25 kHz / 12.5 kHz	± 600 kHz	D3000245
144 MHz UNIT (C1)	144–147.99998 MHz	147.00000 MHz	20 Hz / 200 Hz	25 kHz / 12.5 kHz	± 600 kHz	D3000246
144 MHz UNIT (C2)	143.5–148.49998 MHz	147.00000 MHz	20 Hz / 200 Hz	25 kHz / 12.5 kHz	± 600 kHz	D3000278
144 MHz UNIT (D)	144–145.99998 MHz	145.00000 MHz	20 Hz / 200 Hz	10 kHz / 5 kHz	± 600 kHz	D3000247
144 MHz UNIT (E1)	144–147.99998 MHz	147.00000 MHz	20 Hz / 200 Hz	10 kHz / 5 kHz	± 600 kHz	D3000248
144 MHz UNIT (E2)	143.5–148.49998 MHz	147.00000 MHz	20 Hz / 200 Hz	10 kHz / 5 kHz	± 600 kHz	D3000279
144 MHz UNIT (F)	144–145.99998 MHz	145.00000 MHz	20 Hz / 200 Hz	20 kHz / 10 kHz	± 600 kHz	D3000249
430 MHz UNIT (A)	430–439.99998 MHz	433.00000 MHz	20 Hz / 200 Hz	25 kHz / 12.5 kHz	± 5 MHz	D3000238
440 MHz UNIT (X)	440–449.99998 MHz	445.00000 MHz	20 Hz / 200 Hz	25 kHz / 12.5 kHz	± 5 MHz	D3000239
430 MHz UNIT (B)	430–439.99998 MHz	433.00000 MHz	20 Hz / 200 Hz	25 kHz / 12.5 kHz	± 7.6 MHz	D3000240
430 MHz UNIT (C)	430–439.99998 MHz	433.00000 MHz	20 Hz / 200 Hz	25 kHz / 12.5 kHz	± 1.6 MHz	D3000241
430 MHz UNIT (F)	430–439.99998 MHz	433.00000 MHz	20 Hz / 200 Hz	20 kHz / 10 kHz	± 5 MHz	D3000242

Note: Model F is for use in Japan only, and cannot be readily converted to other models.

SEMICONDUCTORS

(includes SAT Unit, but not RF Modules)

FCD:			Transistors:		Diodes:				
FIP12A5A	1	μ PA80A	3	2SA496Y	1	1S188FM	12	HZ3B2	1
		μ PC78L05	2	2SA733AP	2	(Ge Diode)		(Zener Diode)	
ICs:		μ PC577H	1	2SA733AQ	18	1S1555	3	HZ6B2	1
AN6561	2	μ PC1037H	10	2SC460B	10	(Si Diode)		(")	
HD10551P	2	μ PC1158H2	1	2SC496Y	1	1S1588	8	HZ9C1	1
MC14001B	1	μ PC2002H	1	2SC535B	9	(")		(")	
MC14011B	3	μ PC7805H	1	2SC945AP	45	1SS53	101	HZ11B1	1
MC14013B	1	μ PC7808H	1	2SC1383R	1	(")		(")	
MC14069UR	5	μ PD5101LC	2	2SC1583	3	1SS97	2	MV12	1
MC14072B	1	μ PD7801G-090	1	2SC1815BL	2	(Schottky Barrier Di.)		(Varistor Diode)	
MC14081B	2	μ PD8255AC-5	1	2SC1815GR	8	1SV50	1	MV103	2
MC14094B	4	μ PD8279C-5	1	2SC2002L	1	(Varactor Diode)		(")	
MC14503B	1			2SD717-O	1	1SV80	1	PG4632K	4
MC14515B	1	FETs:		2SD892Q	1	(PIN Diode)		(LED)	
SN7416N	2	2SK30AY	2	MPS-A13	1	1T25	2	PR4632K	2
TC5081AP	2	2SK125	1			(Varactor Diode)		(")	
TC5082P	3	2SK192AGR	3			10D1	1	S5VB10	1
TC9122P	2	2SK241Y	4			(Si Diode)		(Si Diode Bridge)	
		3SK73Y	6			BG4632K	4	S11B	1
						(LED)		(Si Diode)	
						FC53M-5	3	TLG205	1
						(Varactor Diode)		(LED)	
								TLR205	1
								(")	

50 MHz Unit

ICs:		Diodes:	
M57735	1	1S1554	1
MB84074R	1	(Si Diode)	
MC14081B	1	1S1588	1
MC14094B	1	(")	
MC14504B	1	1SS53	23
MC14560B	1	(")	
SN16913P	1	1SS97	2
SN76514N	1	(Schottky Barrier Di.)	
TC5081AP	1	1SV50	4
TC9122P	1	(Varactor Diode)	
μ PC78L05	1	1T25	10
μ PC7808H	1	(")	
		MV13	1
FETs:		(Varistor Diode)	
2SK125	2	V06B	4
2SK192AGR	1	(Si Diode)	
2SK241Y	4	WZ090	1
3SK51-03	1	(Zener Diode)	
3SK73Y	2		
3SK74Y	1		

144 MHz Unit

Transistors:		ICs:	
2SA564A	1	M57713	1
2SA733AQ	1	MB84024B	1
2SC460B	2	MC14081B	1
2SC535B	1	MC14094B	1
2SC945AP	12	MC14504B	1
2SC2053	1	MC14560B	1
2SD471L	2	SN16913P	1
2SD892Q	2	SN76514N	1
		TC5081AP	1

RF Modules

		Transistors:	
TC9122P	1	2SA733AQ	2
μ PC78L05	1	2SC460B	3
μ PC7808H	1	2SC945AP	10
		2SC1426	1
FETs:		2SC2026	2
2SK125	2	2SC2407	1
2SK192AGR	1	2SD892Q	2
2SK241Y	4		
3SK53-03	1		
3SK70	1		
3SK73Y	1		
3SK74L	1		

430 MHz Unit

ICs:		Diodes:	
MC14081B	1	1S1555	2
MC14094B	1	(Si Diode)	
MC14504B	1	1SS53	14
MC145143P	1	(")	
ND487C1-3R	1	1SS97	3
(Ring Module)		(Schottky Barrier Di.)	
ND487C2-3R	1	1T25	3
(")		(Varactor Diode)	
S-AU4	1	MI301	2
SN16913P	2	(PIN Diode)	
TC5081AP	1	V06B	4
TC5082P	1	(Si Diode)	
TC9122P	2		
μ PC78L05	1		
μ PC7808H	1		
		FETs:	
		2SK125	2
		2SK192AGR	2
		2SK241Y	6
		3SK51-03	1
		3SK73Y	2
		3SK121	1

FRONT PANEL CONTROLS

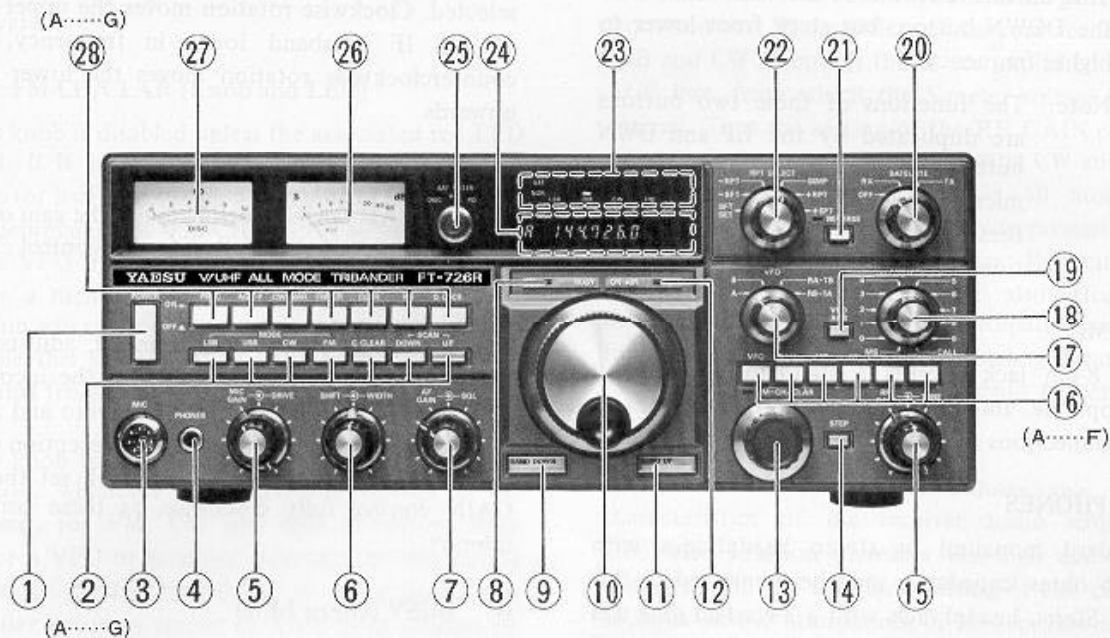

Please refer to the installation procedure on page 16 before connecting the FT-726R to the power source.

① POWER

This is the main ON/OFF switch for the transceiver. If the BACKUP switch under the top cover is in the OFF position, switching the POWER off will also clear the memories in the transceiver. Otherwise, the internal lithium battery will retain the memory information regardless of the setting of this switch, or the removal of external power.

② Push Button Switches (small)

When any of these momentary-contact switches are pressed, a short beep will sound, indicating that the command has been accepted by the CPU.

(A) LSB

Press this button to select lower sideband SSB operation on the selected VFO.

(B) USB

Press this button to select upper sideband SSB operation on the selected VFO.

(C) CW

Press this button to select CW operation on the selected VFO.

(D) FM

Press this button to select FM operation on the selected VFO.

(E) C. CLEAR

Pressing this button clears the clarifier memory to zero, cancelling any offset previously tuned when the clarifier was on. Otherwise the clarifier offset will be retained in the memory.

(F) SCAN-DOWN

Press this button momentarily to cause the operating frequency to move down one step. Hold it in for about 1/2 second to activate the scanner, after which it may be released and scanning will continue until it is again pressed. To manually resume scanning, press this button again for 1/2 second. When operating from a memory channel, use the SCAN-DOWN button to start and stop limited band or memory channel scanning.

(G) SCAN-UP

This button functions in the same manner as the DOWN button, but steps from lower to higher frequency.

Note: The functions of these two buttons are duplicated by the UP and DWN buttons on the MH-1B8 and MD-1B8 microphones. The FST button on these microphones duplicates the function of the STEP button (page 7).

③ MIC

This 8-pin jack accepts a standard or scanning microphone. Impedance should be 600 ohms, and pin connections are shown on page 14.

④ PHONES

Standard monaural or stereo headphones with 4–16 ohms impedance may be connected to this jack. Stereo headphones with a 3-contact plug will reproduce the audio in both ears, as with monaural headphones and a 2-contact plug. Inserting the plug into this jack disables the internal speaker, or external speaker, if connected.

⑤ MIC GAIN DRIVE

The inner MIC GAIN control sets the input level from the microphone to the transmitter audio amplifier for SSB and FM transmission. SSB power output level can thus be adjusted by this control.

The outer DRIVE control adjusts the RF carrier (power output) level during CW and FM transmission.

⑥ SHIFT WIDTH

During CW and SSB reception, the inner SHIFT control tunes the relative position of the receiver IF passband with respect to the frequency to which the receiver is tuned. The control is detented at the center position, and turning the control clockwise raises the center frequency of the passband, while turning it counterclockwise lowers the center frequency. When set to the center position, the passband center frequency is aligned with the receiving frequency shown on the display.

The outer WIDTH control adjusts the IF bandwidth of the receiver during CW and SSB reception. Maximum bandwidth is provided when this control is set in the center detent, and is equal to

the combined selectivity of the standard and/or optional (CW) IF filters in use for the mode selected. Clockwise rotation moves the upper skirt of the IF passband lower in frequency, and counterclockwise rotation moves the lower skirt upwards.

⑦ AF GAIN SQL

The inner AF GAIN control adjusts the gain of the receiver audio amplifier. Rotate this control clockwise to increase the volume.

The outer SQL (squelch) control adjusts the receiver threshold level (relative to the incoming signal level) at which the receiver audio and automatic scan stop are disabled during reception of all modes. Before adjusting this control, set the RF GAIN control fully clockwise, as these controls interact.

⑧ BUSY (Green LED)

During reception, this indicator will be lit whenever the squelch is opened. During SSB and FM transmission, this LED serves as a modulation level indicator to facilitate proper adjustment of the MIC GAIN control. When the Satellite Unit is installed and the transceiver is operated full duplex, this LED indicates both of the above functions simultaneously.

⑨ BAND DOWN

When receiving on a VFO, press this button momentarily to step the frequency down 1 MHz (except from the lowest MHz range of the band, in which case the frequency will step to the top edge of the next lower band). If the transceiver is tuned to the lowest portion of the lowest frequency band, and this button is pressed, the frequency will jump to the high edge of the highest frequency band. Hold this button in for multiple stepping.

⑩ Tuning Knob

This knob tunes the selected operating VFO at a rate of 10 kHz per turn, unless the STEP button is depressed to select 100 kHz per turn.

⑪ BAND UP

This button functions in the same manner as the BAND DOWN button, stepping higher in frequency to the top portion of the highest band and then to the low edge of the lowest band.

⑫ ON AIR (Red LED)

This indicator lights whenever the transmitter is activated.

⑬ FM-CH/CLAR (Knob and LED)

This knob is disabled unless the associated red LED is lit. It is activated to tune standard FM channel steps (or half-steps if the STEP button is depressed) by depressing the FM-CH button when operating on a VFO in the FM mode. When operating FM from a memory channel, depressing the FM-CH button will cause the indicator to light, but will not enable this knob to tune away from the memory channel frequency.

This knob is also activated as the clarifier tuning control, whenever the CLARifier button is depressed; for FM, CW and SSB reception, from either a VFO or memory channel. Clarifier tuning steps are 20 Hz per detent of the control, and clarifier offset is stored in RAM until cleared by the C. CLEAR button. When this knob is rotated clockwise, the clarifier offset frequency is raised, and when rotated counterclockwise the frequency is lowered. If the clarifier offset is below the transceiver frequency, a minus sign appears to the left of the clarifier frequency display. The clarifier function of this knob has priority over the FM channel tuning function when both are activated at the same time.

⑭ STEP

This button functions in conjunction with the FM-CH/CLAR knob when activated for the FM-CH function only, allowing selection of either full or half-channel step tuning by the knob or scanner.

Also, when scanning from a VFO or during limited band scan operation from memory channels, the STEP button selects the scanning rate of 2 kHz or 20 kHz (when depressed) per second for CW and SSB operation, and FM operation when the FM-CH function is not activated. The functions of the STEP button are duplicated by the FST button on the microphone.

When operating from a VFO and tuning with the main knob, the STEP button selects tuning rates of 10 kHz or 100 kHz (when depressed), per revolution.

⑮ RF GAIN TONE

The inner RF GAIN control adjusts the gain of the front-end and IF amplifiers of the receiver. During SSB and CW reception this is accomplished by the AGC line, from which the S-meter voltage is also derived. Thus the setting of the RF GAIN control will affect S-meter deflection during CW and SSB reception. Receiver sensitivity in all modes is affected, with the greatest sensitivity present when this control is set fully clockwise. Reducing the sensitivity with this control will also effect the operation of the squelch and automatic scan-stop functions, so unless signals are strong enough to cause distortion, this control should be set fully clockwise.

The outer TONE control adjusts the audio characteristics of the receiver audio amplifier. Clockwise rotation increases the high audio frequencies, and the optimum setting of this control depends on the headphones or loudspeaker in use, and the preference of the operator.

⑯ Push Button Switches (medium size, momentary contact)

With the exception of the CALL button, pressing these buttons will cause a short beep to sound when the CPU accepts the command. If the beep does not sound, the command was not accepted because of incompatibility of the command with the present operating status of the CPU. For example, if the scanner is activated, only the CALL button in the tone burst function will have any effect on operation. All other buttons are disabled during scanning.

(A) VFO

Press this button to change the operating frequency source from a memory channel (or the priority function) to VFO A or B, as determined by the setting of the VFO selector. If operation is already occurring from a VFO and this button is pressed, operation is unaffected and no beep will sound.

(B) CALL

This button has one of two functions, depending on the model type of the FT-726R. One of these functions is burst tone activation. In

this case, pressing this will activate the transmitter and, if the BURST switch on the top cover is set to ON, a 1750 or 1800 Hz tone will be transmitted for as long as the CALL button is depressed.

In other models, pressing this button simply recalls the frequency and mode stored in the CALL memory channel.

(C) MR

This Memory Recall button selects operation on the mode and frequency stored in the memory channel to which the MEMORY selector is set, when operation was previously from a VFO (or the priority function). Once the MR button has been pressed, the memory channel may be changed by the MEMORY selector, or memory scanning or limited band scanning may be activated. The Tuning Knob and the FM-CH functions are disabled.

(D) PRI

This button activates the PRIority channel checking function, in which the memory channel selected by the MEMORY selector is automatically checked for activity every five seconds during reception on one of the VFOs. The scanner is disabled during priority operation, as are the M→V and MW buttons. The CALL button is not disabled for the tone burst function. Pressing either the VFO or MR buttons will cancel the priority channel checking function.

(E) M→V

Pressing this button transfers the memory channel frequency and mode selected by the MEMORY selector and displayed on the frequency display into the selected VFO. Operation must be from the memory channel (MR button pressed previously), as this button is deactivated during operation from a VFO. The mode and frequency data previously stored in the selected VFO will be overwritten.

(F) MW

When operating from a VFO, pressing this button causes the operating frequency and mode of the selected VFO to be stored in the memory channel selected by the MEMORY

selector. Previously stored mode and frequency data in that channel is overwritten. This Memory Write button has the converse function of the M→V button.

⑰ VFO Selector

This rotary switch selects between VFO A and VFO B for transceive or split frequency operation, when the VFO function is activated by the VFO button. Frequency and mode data for each VFO are stored independently from the memories and from one another, but retained by the lithium backup battery in the same manner as the memories. The A and B positions of this selector are for simplex operation only

The RA-TB (receive on VFO A, transmit on VFO B) and RR-TA (vice-versa) positions are for split frequency operation, and for full duplex operation when the optional Satellite Unit is installed and activated.

⑱ MEMORY Selector

The “0” through “9” positions of this selector are for storing and recalling the memory channels. To ensure proper operation of the limited band scanning function, the lowest memory frequency should be stored in channel 0, and the highest in channel 9, with other memory frequencies in order between the two.

An eleventh memory channel, MEMORY position “CALL”, is also available for all memory functions except limited band scanning. In models not equipped for the burst function of the CALL button, this memory is recalled instantly when the CALL button is pressed.

The “MS” position of the MEMORY Selector is for memory scanning. When this selector is set to this position during memory operation, and the SCAN-UP or DOWN button is pressed, the operating frequency will shift to the next memory channel frequency (and mode). If one of the scan buttons is held in for about one second, scanning of the memory channels will begin.

19 VFO A=B

Pressing this button while receiving from either VFO A or B, will cause the frequency and mode of the VFO that is displayed to overwrite the previous contents of the VFO that is not displayed. The previous data stored in the non selected VFO is thus lost. Operation must be from a VFO or the priority mode, receive only.

20 SATELLITE Selector

When the optional Satellite Unit is installed, this rotary switch selects the operating parameters to be displayed and accessed by the transceiver mode and frequency controls during full duplex operation. For other types of operation, or if the Satellite option is not installed, this selector should be set to the OFF position. All operation must be from the VFOs during full duplex operation.

21 REVERSE (Pushbutton and LED)

When operating semi duplex using the repeater shift function, press this button to exchange the transmit and receive frequencies (while receiving). The Red indicator next to the button will be lit during reverse shift operation, and pressing the button again will return the transceiver to the original shift. The REVERSE function can not be used for exchanging the contents of VFO A and VFO B during split frequency operation using the two VFOs, but this can be done with the RA-TB and RB-TA positions of the VFO Selector.

22 RPT SELECT

This selector is used for repeater operation, selecting plus or minus standard or programmable shifts. The SIMP position is used when simplex operation or semi or full duplex operation between VFOs A and B is desired.

The SFT SET position is used for programming non-standard repeater shifts. When the RPT SELECTOR is set to this position, all other transceiver controls are disabled (except the MW button and tuning knobs, used for setting the shift), and the frequency display indicates the programmed shift. The -SFT and +SFT positions then select the direction of the programmed shift (receive-to-transmit frequency).

The -RPT and +RPT positions select standard repeater shifts for the operating band selected, according to local policies and regulations. These

standard shifts are programmed at the factory in the different models of FT-726R for different countries.

Note: If the repeater shift is selected so as to attempt operation outside of the maximum band limits of the transceiver, the Error mode will automatically disable transceiver operation. When this occurs the frequency display will show an "E" at the left side, and the RPT SELECTOR must be set to another position.

23 Mode Indicator LEDs

These eight LEDs indicate the operating mode of the transceiver. One of the upper (dark green) indicators will be lit during full duplex operation with the optional Satellite Unit. Otherwise, only the lower (light green) indicators are used, indicating the mode of the operating VFO or memory channel.

24 Digital Display

During normal operation, the source of the operating frequency is indicated by the first character at the left side of the display, except during the Error mode, as described in the note above.

The seven digits in the center of the display show the VFO or memory frequency to the nearest 100 Hz, as shown in the figure. When the CLARifier is activated, two additional digits appear at the right side of the display, indicating the frequency difference between the selected VFO or memory and the clarified operating frequency, from zero to +9.9 kHz. When this offset causes the operating frequency to be lower than the displayed frequency, these two digits are preceded by a minus sign.

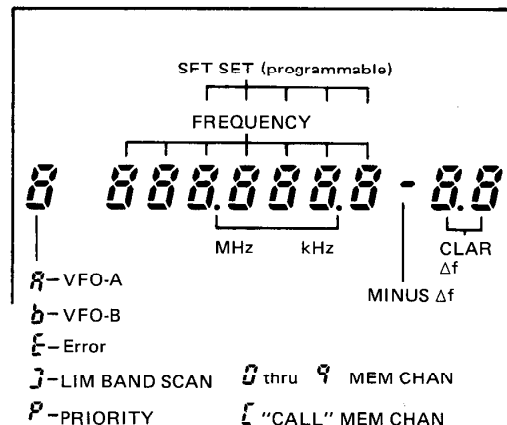

25 SAT METER

This selector determines the function of Meter I during full duplex operation. In the DISC position, when receiving FM, Meter I will indicate receiver DISCRiminator center tuning while Meter II indicates received signal strength. When the SAT METER Selector is set to the ALC position, Meter I indicates transmitter ALC (see Meter I figure), while Meter II indicates received signal strength. In the PO position, Meter I indicates transmitter output power while Meter II indicates received signal strength.

26 Meter II

This meter indicates received signal strength in S-units during reception and full duplex operation with the optional Satellite Unit. Otherwise, during transmission, this meter indicates relative transmitter ALC on the lower scale.

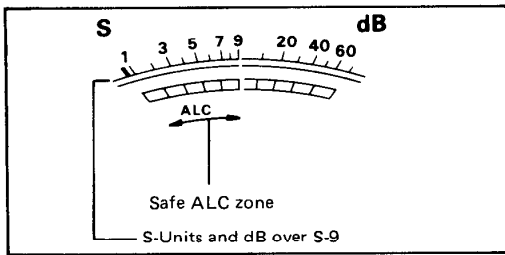

27 Meter I

Except during full duplex operation, this meter indicates relative forward power output in watts during transmission of all modes, and DISCRiminator center tuning during FM reception. This meter is de-activated during CW and SSB reception, except during full duplex operation, when its function is determined by the SAT METER selector.

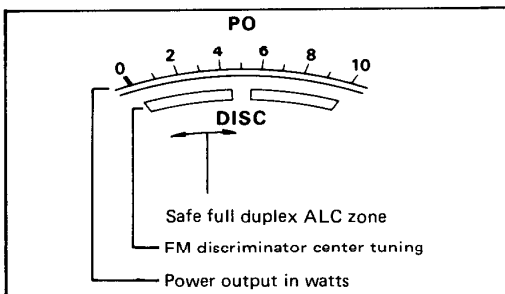

28 Push Button Switches (large, 2-position)

(A) PROC

When this button is depressed the audio speech PROCessor is activated for SSB transmissions (only).

(B) AGC-F

When this button is depressed the fast AGC decay rate is selected for SSB and CW reception, especially useful for scanning. When this button is in the out position the slow AGC decay rate is selected.

(C) CW NAR

During CW reception when the optional XF-455MC CW narrow filter is installed, this button selects narrow CW selectivity through the filter.

(D) FM-CH

During FM operation, pressing this button will cause the FM-CH/CLAR indicator to light, indicating that FM channel step tuning is activated (via the FM-CH/CLAR knob or scanner), unless the overriding CLAR function is activated simultaneously.

(E) CLAR

Press this button to activate the CLARifier function. When activated, two additional digits will appear to the right of the operating frequency on the display, and the FM-CH/CLAR indicator will be lit. The SCAN-UP and -DOWN buttons and main tuning knob will be disabled, and the FM-CH/CLAR knob will tune the receiving frequency away from the displayed frequency at a rate of 20 Hz per detent.

Note: Clarifier offset is retained in RAM whether the CLAR button is on or off. The C. CLEAR button cancels the offset.

(F) NB

Press this button to activate the noise blanker when impulse noise is present during SSB or CW reception.

(G) D. LOCK

When this button is pressed all tuning, stepping and scanning functions are disabled. However, VFO and memory channel selections and interchanges can still be made, and priority channel checking operation is still possible.

TOP COVER SWITCHES

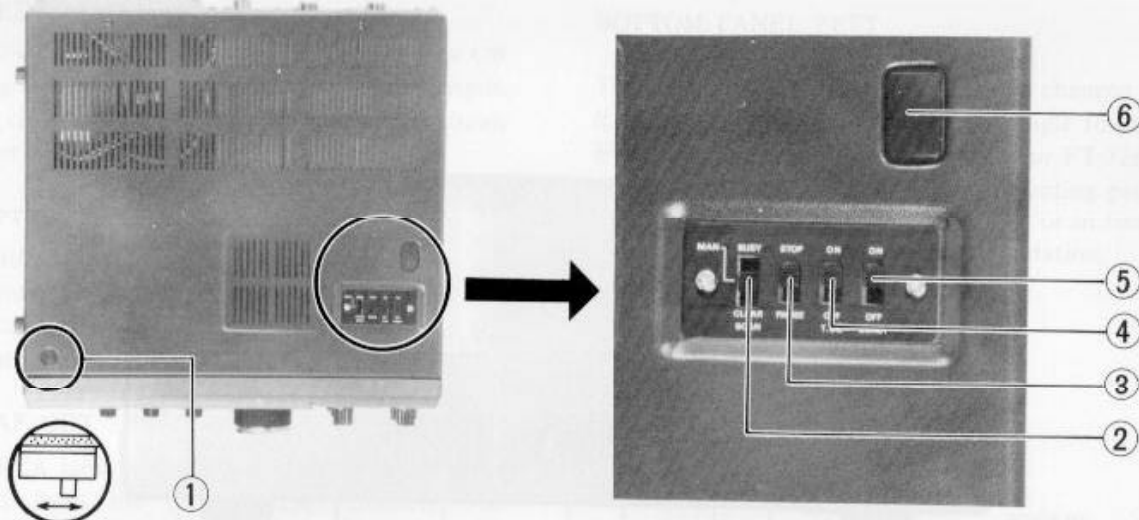

① Memory Backup

This miniature slide switch is located beneath the rubber plug. When set to the OFF position, all memory information will be erased whenever the POWER switch on the front panel is off, or the power supply disconnected. When ON, the internal lithium battery will retain all memory information, including programmed repeater shift, clarifier offset, and VFO and memory channel frequencies and modes. Backup current is so small that the life of the battery is not significantly affected by the position of this switch, so we recommend that it be kept in the ON position.

② SCAN

This three-position slide switch is used to select the scan-stop condition for all scanning and priority operation. When set to the BUSY position, the scanner will automatically halt whenever a received signal or noise is strong enough to open the receiver squelch (set by the SQL control).

When set to the manual position, the scanner will stop only when manually directed to do so by pressing the SCAN buttons on the front panel or microphone, closing the PTT line, or pressing the CALL or MW buttons (not recommended).

When the SCAN switch is set to the CLEAR position, the scanner will automatically halt whenever the receiver squelch closes, indicating a clear frequency.

③ STOP/PAUSE

This two-position slide switch determines the halt

status of the automatic scan-stop. When this switch is set to STOP, and the SCAN switch is set to BUSY or CLEAR, scanning will not resume unless so directed manually by the SCAN buttons on the front panel or microphone.

When this switch is set to PAUSE and the SCAN switch is set to BUSY or CLEAR, scanning will resume automatically after about five seconds, unless interrupted manually by pressing the PTT switch or SCAN buttons again. During the pause, the decimals of the displayed frequency will blink, indicating that the automatic scanner is still active.

④ T. SQ

When an optional subaudible tone squelch (CTCSS) unit is installed, this switch turns the unit on and off.

⑤ BURST

This switch controls the internal 1750 or 1800 Hz tone burst generator for automatic burst. When this switch is set to the on position, the transmitter will automatically send a 0.5-second burst tone each time the PTT line is closed. When this switch is in the off position, tone burst can still be sent manually by the CALL switch on the front panel.

⑥ Tone Squelch Access Plug

When an optional CTCSS unit is installed under this plug, the DIP switches on the unit may be accessed to reprogram the tone frequency. Otherwise, this plug should remain in place for protection.

REAR PANEL CONNECTIONS

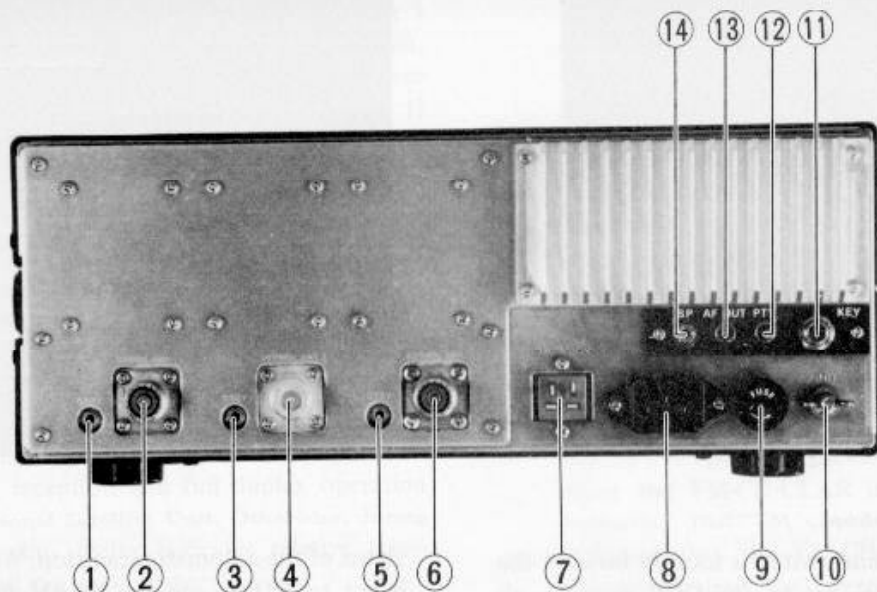

①, ③, and ⑤ STBY

These three 1/8-inch mini phone jacks provide control signals for external RF power amplifiers. Each provides a closed circuit on transmit, open on receive (between the two jack contacts). The standard configuration of modules entails the 50 MHz Module being installed in the outermost position, the 144 MHz Module in the innermost position, and the 430 or 440 MHz Module in between, although this may be varied. The correct STBY jack for a certain band will depend on the placement of the module for that band.

② 50 MHz ANT

The 50 MHz antenna feedline should be connected to this jack using a type M connector when the 50 MHz Module is installed in this position.

④ 430 MHz ANT

The 430 or 440 MHz antenna feedline should be connected to this jack using a type N connector, according to which Module is installed in this position.

⑥ 144 MHz ANT

The 144 MHz antenna feedline should be connected to this jack using a type M connector, when the 144 MHz Module is installed in this position.

⑦ DC 13.8V

This 4-pin jack accepts DC supply voltage for the transceiver when used with the optional DC power cord. Otherwise, for AC operation, the dummy plug must be connected here. Current drain is approximately 4.5A during transmission. If both DC and AC power are supplied at the same time, the transceiver will draw current from the DC supply only. Do not apply AC voltage to this jack.

⑧ AC

This 3-pin jack accepts the AC power cord for operation from standard AC lines. Do not apply DC voltage here. The dummy plug must be connected to the DC 13.8V jack for transceiver operation from the AC line.

⑨ FUSE

For AC line voltages of 100, 110, or 117V, a 2A fuse must be installed in this socket.

For AC line voltages of 200, 220 or 234V, a 1A fuse must be installed. Use no other size.

⑩ GND

For best performance and safety, connect this terminal to a good earth ground through the shortest path possible.

⑪ KEY

This 2-contact 1/4-inch phone jack accepts the CW keying signal from a straight key or keyer output. Open circuit voltage is 8 VDC, and closed circuit current is 0.8 mA.

⑫ PTT

This RCA jack is connected in parallel with the PTT line, for external T-R control. Shorting the two contacts will switch the transceiver to the transmit condition.

⑬ AF OUT

This RCA jack provides a constant level of audio output from the receiver; approximately 500 mVp-p at 600 ohms impedance.

⑭ SP

This 1/8-inch 2-conductor mini phone jack provides audio output for an external speaker. Speaker impedance should be 4–16 ohms, and the tone and level of this audio is controlled by the TONE and AF GAIN controls on the front panel.

BOTTOM PANEL FEET

The feet on the bottom panel may be changed, if it is desired to change the viewing angle for the FT-726R. In the accessory kit for your FT-726R there are two extender feet with mounting pads. These may be installed either in front or in back, according to the requirements of your station.

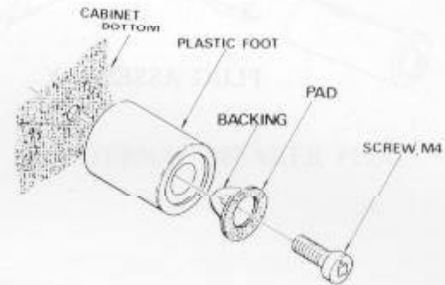

MD-1B8/SP-102/FT-726R

MICROPHONES

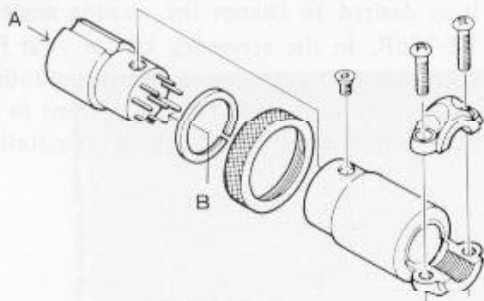

PLUG ASSEMBLY



MD-1D0

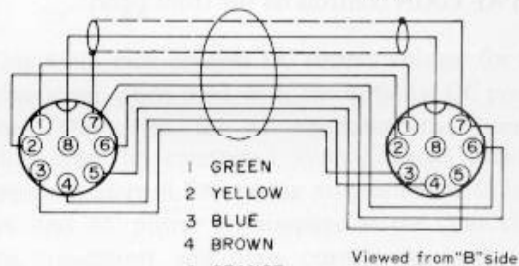
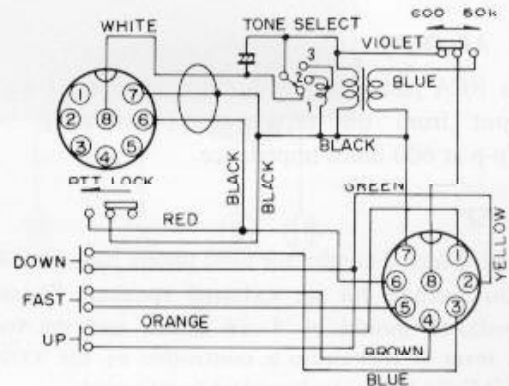
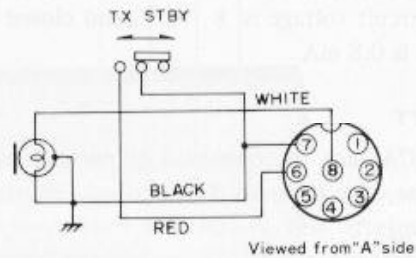

MH-1B8

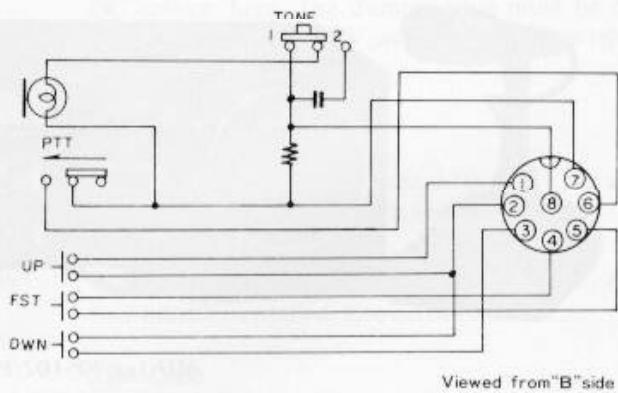

PLUG CONNECTIONS

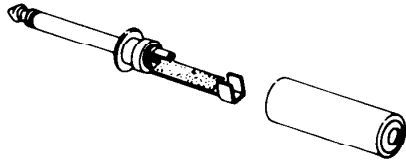

MONAURAL HEADPHONE PLUG

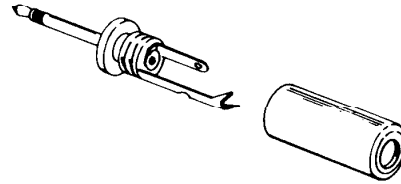
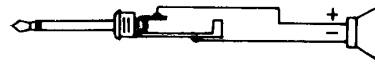

EXTERNAL SPEAKER PLUG

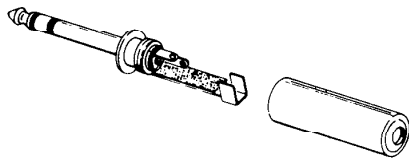
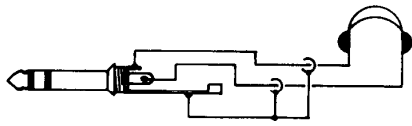

STEREO HEADPHONE PLUG

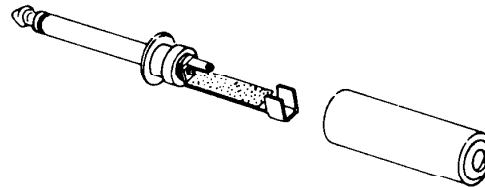
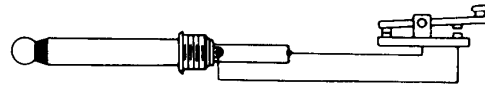

KEY PLUG

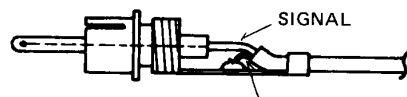

GROUND (SHIELD)

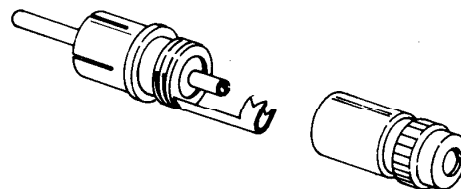

PTT, REC PLUGS

INSTALLATION

The FT-726R is designed for operation from AC power, or from 13.8V DC with the optional DC cable. Power supply connections providing for operation from a variety of AC source voltages are available.

PRELIMINARY INSPECTION

Upon opening the packing carton, immediately give the transceiver a thorough visual inspection. Check to see that all controls and switches are working freely, and inspect the cabinet for any signs of damage. If any damage has been sustained, immediately contact the shipping company, and document the damage completely. Save the packing carton and foam packing material for possible use at a later date.

AC POWER CONNECTION

The FT-726R is designed for use in many areas of the world, using a variety of different supply voltages. Be absolutely certain that the voltage specification marked on the rear of the transceiver agrees with the local AC supply voltage. **THIS INSPECTION MUST BE MADE BEFORE CONNECTING THE AC POWER CORD TO THE REAR APRON OF THE TRANSCEIVER.** If the transceiver is wired for another supply voltage,

change the connections to the primary of the power transformer as shown below. Also change the label on the rear panel. The dummy plug supplied with the transceiver must be be connected to the DC 13.8V jack to enable AC operation.

Note

Before connecting AC power for the first time, check the current rating of the fuse in the FUSE holder on the rear panel. This must be a 2A type for 100–117 VAC operation, or a 1A type for 200–234 VAC operation. Also, if the power transformer primary wiring is changed, the fuse must be checked, and if necessary, replaced.

TRANSCEIVER LOCATION AND GROUND

In all station installations, a primary consideration is adequate air circulation around the heat sink and through the case. Do not place books or papers on or around the cabinet, and do not place the FT-726R on top of another heat-generating device, such as a linear amplifier. Avoid heat ducts and window locations that might expose the transceiver to excessive direct sunlight, especially in warm climates. Locate the transceiver so as to allow the shortest length of antenna feedline possible.

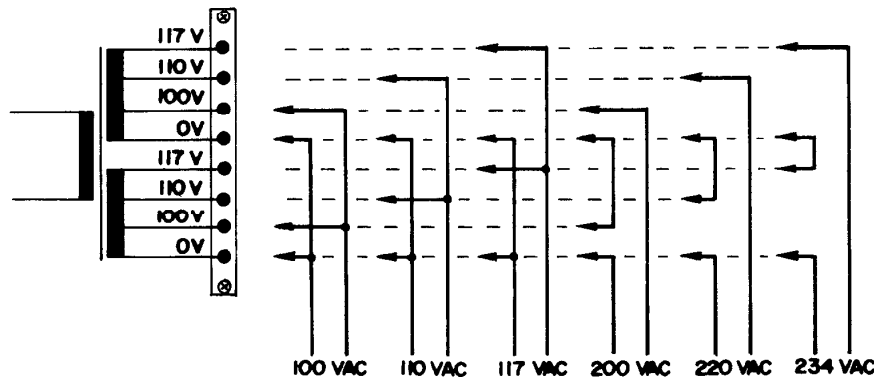

POWER TRANSFORMER PRIMARY CONNECTIONS

Ground the transceiver using a heavy braided cable of the shortest length possible. Water pipes are generally not satisfactory as grounding points; it is better to use earth rods with the grounding cable securely connected to each point in the ground system.

ANTENNA CONSIDERATIONS

For best performance, all antennas used with the FT-726R should present 50 ohms resistive impedance to the transceiver across the respective operating band. In general, each band requires a different antenna, and operation on certain modes ideally also requires different antenna polarization. For example, FM communications usually use vertical polarization, while SSB and CW use horizontal polarization, except for satellite communications, which use both, or circular polarization.

Space here does not permit adequate description of the numerous types of antennas to determine which is best for your particular requirements, but we do recommend referring to publications dealing directly with antennas for VHF and UHF, in order to obtain the best performance from the FT-726R. Your Yaesu dealer may also have some helpful advice.

Regardless of what type of antenna is used with the FT-726R, special attention should be paid to the feedline between the transceiver and antenna. This should be coaxial cable of the highest quality and largest size practical, and should be kept as short as possible, especially on the higher frequency bands. Do not use any type of cable connectors other than those specifically designed to mate with the coaxial jacks on the rear of each Band Module; type M connectors for the lower frequencies, and type N for the higher frequencies. Poor quality cable or poor connections will degrade performance substantially, particularly on the UHF bands.

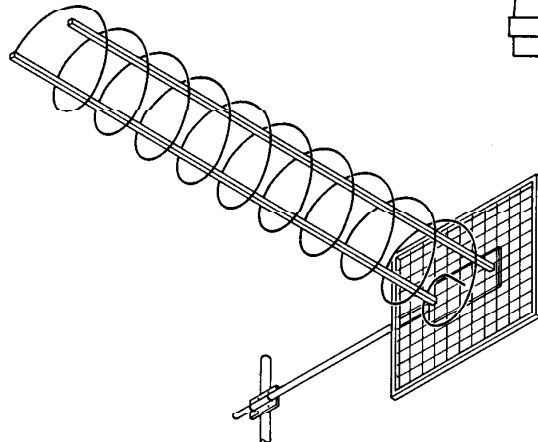
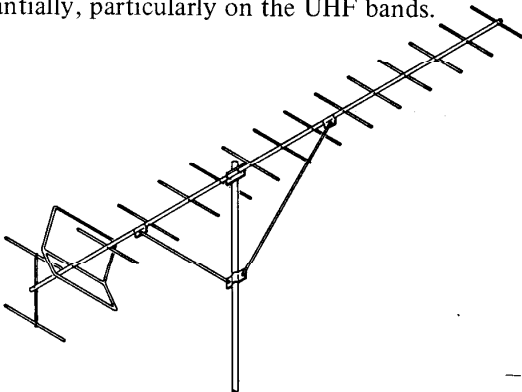
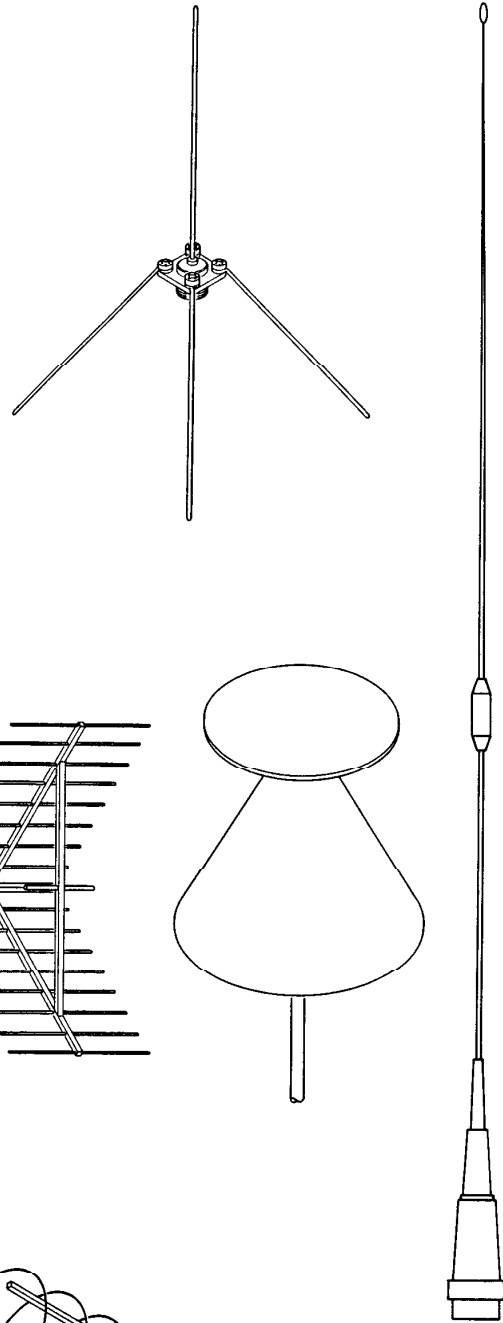

DC OPERATION

The FT-726R can be operated from DC power using the optional DC power cable. This cable includes a fuse holder in which a 5A fuse must be installed. DC voltage should be 13.8V \pm 10% to maintain operating specifications (but in no case above 15V), and the DC source must be capable of providing 4.5A continuously for the transmitter. Connect the RED wire of the DC cable to the positive DC source, and the BLACK wire to negative. When the transceiver is operated from an external DC source, always make sure that the transceiver POWER switch is OFF before connecting, disconnecting or switching the external source.

When the dummy plug is removed from the DC 13.8V jack on the rear panel, the internal AC power supply is disabled, so if the AC power cable is connected to the transceiver at the same time as a DC source, current will be drawn from the DC source only. Use care to avoid applying DC to the AC jack, or AC to the DC jack, as this could damage the equipment.

CAUTION

PERMANENT DAMAGE WILL RESULT IF IMPROPER SUPPLY VOLTAGE OR REVERSED POLARITY DC IS APPLIED TO THE TRANSCEIVER. OUR WARRANTY DOES NOT COVER DAMAGE CAUSED BY APPLICATION OF IMPROPER SUPPLY VOLTAGE. DO NOT CONNECT THE AC POWER CORD TO A DC POWER SOURCE, OR AC VOLTAGE TO THE DC 13.8V JACK.

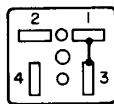
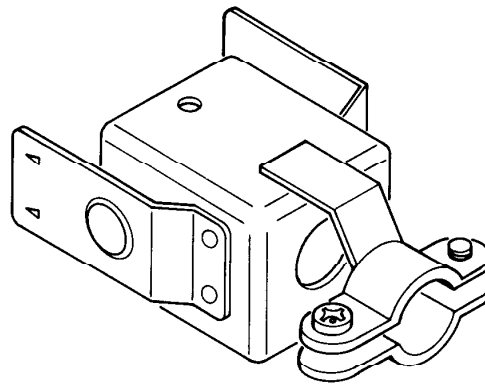
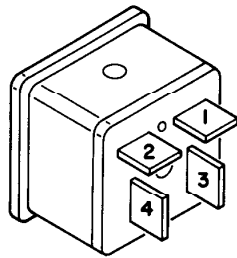

DC Dummy Plug connections

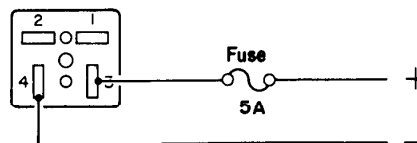

DC Plug connections for external DC supply

OPERATION

The variety of different operating functions in the FT-726R afford substantial flexibility to virtually any amateur radio pursuit on the VHF and UHF bands. However, the operator must familiarize himself with the interdependent functions of the controls in order to obtain optimum performance for his particular requirements.

Before connecting the FT-726R, to the power source, please read the Installation section of this manual on pages 16 and 17, and also the Front Panel Controls section. While becoming familiar with the many fine features of the FT-726R, feel free to refer back to the preceding sections whenever the functions of a particular switch or control become unclear. Certain commands can cause the microprocessor to disable some or most of the normal transceiver functions for protective purposes, though this is not a sign of damage or malfunction. If unable to return the transceiver to normal operation by adjusting the front panel controls, reset the microprocessor by switching the POWER switch off, waiting a few seconds, and then switching on again. If necessary, clear the memories also by switching the Backup switch off while the POWER switch is off, and then turn both switches back on.

Although the following procedures are arranged according to mode, some of which may not be of particular interest to the operator, please study each section in the order that they are written and perform each step with the transceiver controls, so as to gain a clear understanding of each function.

Connect the microphone to the MIC jack on the front panel, and the CW key or keyer output to the KEY jack on the rear panel, if desired.

FM

1. Preset the front panel controls as follows.

POWER OFF
MIC GAIN
 and DRIVE fully counterclockwise
SHIFT and WIDTH . . . 12 o'clock
AF GAIN and SQL . . . fully counterclockwise
STEP button out position
RF GAIN fully clockwise
TONE 12 o'clock
 (adj. later as desired)
VFO Selector "A"
MEMORY Selector . . . "0"
RPT SELECT "SIMP"
SATELLITE Selector "OFF"
SAT METER Selector "ALC"
Large Buttons all out

2. Press the POWER button ON, and notice the display and indicator LEDs. If the transceiver has not been operated previously, or if the Backup switch (page 11) is off, the microprocessor will display the default condition. In this case, the USB mode indicator above the display is lit, and the display shows 147.000.0 (or 145.000.0 in models for use in countries where the upper limit of the 2-meter band is 146 MHz).

Because the VFO selector is set to "A", an "A" is displayed at the left side of the display, and because the SQL (squelch) control is fully counterclockwise, the BUSY indicator is lit (squelch open).

The default frequency and mode conditions will not be met when the Backup switch is on and other frequencies have been tuned previously. Once the memory functions are clear to the operator, the Backup switch should be switched on and left on, and in some cases this switch will be turned on at the factory before shipping. When the Backup switch is on, the mode and frequency displayed with the POWER switch is pressed will be those last tuned when the transceiver was switched off previously. The following procedures will still apply.

3. Press the small FM (MODE) button, and notice that the indicator above the display has changed accordingly. Also notice that Meter I now deflects, indicating discriminator tuning. Rotate the AF GAIN control clockwise until a signal or noise is heard in the speaker.

Press either the BAND DOWN or BAND UP button and notice that the display steps down or up one megahertz. Now hold either of these buttons in and observe the band stepping sequence, which depends on which RF Modules are installed in the transceiver. Step around to a frequency range where local stations are known to be active (and for which a proper antenna is connected).

4. Press the large FM-CH button, and notice that the red indicator above the FM-CH/CLAR knob lights. Rotate this knob to tune the transceiver to a clear channel, where only noise is present and Meter I deflects to center, and advance the SQL control clockwise just to the point where the noise is silenced and the BUSY indicator is extinguished. Now tune the FM-CH/CLAR knob to receive a signal, at which point the BUSY indicator will again light. The signal is precisely tuned when Meter I deflects to the center. Meter II indicates signal strength in S-units. Notice that each detent of the knob steps one full channel step. To tune half-steps, press the STEP button next to the knob.
5. For simplex operation, simply press the PTT switch on the microphone to transmit on the same frequency. Advance the DRIVE control clockwise until the PO indication on Meter I just ceases to increase, while the ALC indication on Meter II remains in the safe zone. Then advance the MIC GAIN while speaking into the microphone with a normal voice, to the point where the green BUSY LED flickers with speech. When adjusting the DRIVE control, PO deflection depends on the antenna impedance, and will be "8" for a 50-ohm resistive load. If the PO reading is less than "5", the antenna is probably mismatched."
6. For repeater operation, set the RPT SELECT knob to the position that corresponds with the shift being used by the repeater. For

standard shifts, use the -RPT position if the repeater is receiving at a lower frequency than that on which it transmits, or the +RPT position if the repeater receive frequency is higher. When the PTT switch on the microphone is closed, the displayed frequency will be that on which your transmission occurs. Set the BURST switch on the top cover to ON, or press the CALL button if a manual burst tone is required.

7. If a repeater is found that does not use the standard frequency shifts for which the FT-726R is programmed, set the RPT SELECT knob to the SFT SET position while receiving. The display will now show only five digits in place of the operating frequency, which will be 0.000.0 unless programmed previously. To program the odd repeater shift, simply tune the FM-CH/CLAR knob until the shift frequency is displayed (use the STEP button if the shift is a multiple of a half-step). If the odd split is not a multiple of either whole or half of the standard FM channel steps, set the shift as close as possible. Then press the FM-CH button to cancel this function and use the main tuning knob to set the exact odd shift on the display. Press the FM-CH button again to reactivate the step tuning function.

Once the correct odd shift frequency is shown on the display, press the MW button at the right side of the front panel to store the odd shift for use. Now rotate the RPT SELECT knob to either -SFT or +SFT, the sign indicating the relative position of the repeater receiving frequency to its transmitting frequency, and close the PTT switch to transmit. Once programmed by the operator, the odd split will be stored in RAM as long as the Backup function is active, or until reprogrammed by the operator.

8. When operating with a repeater offset, it is possible to reverse the normal receiving and transmitting frequencies of the FT-726R, so as to transmit on the output frequency of the repeater and receive on the input. To do this, first tune the transceiver to the frequency and shift used by the repeater, and then press the REVERSE button. The adjacent LED will light if the command is accepted.

NOTE

If either the standard or operator-programmed shift and the operating frequency of the transceiver are related in such a way as to attempt to operate outside of the normal operating band of the transceiver, the displayed frequency will be replaced by an "E", indicating an error mode. This will appear only when transmission is attempted, unless the REVERSE button is pressed, in which case the receiver will continue to function on the last frequency displayed before REVERSE was pressed, but most transceiver functions will be deactivated. When this occurs, press the REVERSE button again to return operation to normal, and recheck the desired shift.

9. It is also possible to tune FM signals between the standard FM channel steps and half-steps. This can be done in two ways, one of which is done with the clarifier, to tune the receive frequency up to ± 9.9 kHz from the transmit frequency. To activate the clarifier function, press the large CLAR button. Two additional digits will appear to the right of the operating frequency, and these will both be zero unless previously programmed otherwise.

Use the FM-CH/CLAR knob to tune the clarifier frequency, which changes 20 Hz for each detent of the knob. Notice that the FM-CH function of this knob is overridden by the CLAR function. The clarifier offset frequency is automatically stored in RAM by the backup system, and is only cleared to zero again by pressing the small C. CLEAR button. However, simply pressing the CLAR button again (returning to the out position), will remove the offset from the receiving frequency. The same clarifier offset will instantly return when the CLAR button is again pressed on, though the transmitting frequency will remain unaffected.

10. Tuning of both the receive and transmit frequencies can be done in 20 Hz steps throughout the range of the selected band, using the main tuning knob. To activate this system, set both the FM-CH button and CLAR button to their off (out) positions.

The rate of tuning by the main knob can be selected by the STEP button, with the depressed position giving course tuning, and the out position, fine tuning. However, if the operating frequency is tuned between FM channel steps using the main knob, and the FM-CH button is then pressed, the operating frequency will jump to the nearest standard channel (or half-channel, if the STEP button is in the depressed position) and the main knob will be disabled. Activating the clarifier will also disable tuning from the main knob.

SSB and CW

1. Perform steps 1 and 2 of the FM procedure, and review the rest of the preceding section.
2. Press either the LSB, USB or CW MODE buttons for the respective mode desired. Meter I will now deflect to zero, and will remain inactive during reception of these modes. Also notice that, if the FM-CH button is depressed when the mode is changed from FM (but the CLAR button is not depressed), the FM-CH/CLAR indicator will be extinguished. Use the BAND DOWN or UP buttons and the main tuning knob to change the operating frequency for these modes. Again, the STEP button provides two tuning rates for the main knob.
3. Press the AGC-F button when tuning around the band for SSB or CW signals, and return this button to the off position for best copy on strong signals, except when fast fading is present. If impulse noise is encountered, press the NB button. Otherwise this button should be kept off (out).

4. For simplex operation, the RPT SELECT knob must be set to the SIMP position. Otherwise, repeater offsets function in the same manner as for FM. For SSB transmission, simply close the PTT switch on the microphone and adjust the MIC GAIN control while speaking with a normal voice, watching the ALC indication on Meter II to ensure that it remains within the black zone at the left half of the scale. PO indication on Meter I will be lower than the actual PEP output during normal speaking, but the average output power indicated here can be increased by pressing the PROC button to activate the speech processor.
 5. For CW transmission, close the key and adjust the DRIVE control just to the point where Meter I indicates 10 (watts) on the PO scale.
 6. Reception of SSB and CW can be greatly improved in crowded conditions by careful adjustment of the SHIFT and WIDTH controls. Once the desired signal has been tuned in, if interference is only noticed on one side of the signal, adjust the outer WIDTH control to the right or left to cut the interference out of the receiver passband (the SHIFT control will also work for this, but may introduce interference from the other side of the signal).
7. The squelch function can be used for SSB and CW reception in the same manner as for FM, by tuning to a clear frequency and setting the SQL control just to the point where the noise is silenced. This feature is especially useful when waiting for a station of known signal strength to call, keeping the receiver quiet otherwise. However, very weak signals will require that the SQL control is set fully counterclockwise.
 8. The received signal strength of SSB and CW signals is indicated in S-units on Meter II. In some situations where very strong signals are present on the band, reception may be improved by reducing the setting of the RF GAIN control from its fully clockwise position. This will reduce the sensitivity of the receiver, as indicated by the higher minimum indication point on Meter II, and will affect the threshold point of the SQL control. Normally, the RF GAIN control should be kept fully clockwise for maximum sensitivity, but if it is reduced the SQL control should be reset when squelch is desired. This also applies to FM operation, except that reduced sensitivity will not cause a change in the minimum deflection point of Meter II.

When interfering stations are on both sides (higher and lower frequencies), first adjust the SHIFT control just to the point where interference from one side is eliminated, and then rotate the WIDTH control in the opposite direction to eliminate interference from the other side. The optimum settings for these controls depend on the relative strengths and frequencies of the desired and interfering signals, and can be achieved only through practice.

When adjacent signal interference is not present, the SHIFT and WIDTH controls should be returned to their 12 o'clock positions when tuning the receiver to a new frequency. For CW reception only, when the optional narrow CW filter is installed, press the CW NAR button before adjusting the SHIFT and WIDTH controls, as such adjustment may be unnecessary.

Memory System

1. During reception of any mode, the receiving frequency and mode can be stored in memory. First rotate the MEMORY selector to the desired memory channel number, 0 through 9 or CALL, and then press the MW button (a beep will sound). If the clarifier is on and tuned to offset from the main frequency, the memory will store the clarified frequency displayed—not the main frequency. Use channel 0 for the lowest frequency, increasing frequency with channel number respectively. This ensures proper functioning of the memory scanning system, mentioned later.
2. To recall a channel, simply press the MR button and rotate the MEMORY selector to the desired channel. Notice that the frequency and mode stored in each channel is displayed as the MEMORY selector is rotated, and the memory channel number is displayed to the left of the frequency.
3. Once a MEMORY has been recalled, the clarifier can be used to change the receive frequency. If the memory frequency is for a repeater, the RPT SELECT knob should be set for the appropriate shift before transmitting. To make further changes to the frequency and mode data stored in a memory, press the M→V button to transfer the memory data into the VFO. Data held previously in the VFO will be erased. Then press the VFO button to change operation from the memory function to the VFO (the displayed data will not change). Now the mode and frequency may be altered as described previously. If the new data is to be stored in place of the original data from the memory, simply press the MW button. Otherwise the memory will continue to store the original data.

Scanning

1. While receiving on a VFO (A or B), it is possible to scan throughout the selected band, manually or automatically. To use the manual scanning system, set the BUSY/MAN/CLEAR SCAN switch on the top cover to the MAN position, and press the SCAN DOWN or UP button on the front panel or microphone (a beep will sound). A momentary push will move the frequency just one step, but if the button is held in for 1/2 second, continuous scanning will begin. Scanning steps are the same as for regular tuning from the main knob (or FM-CH/CLAR knob for FM), with the STEP button or microphone FST button changing the scanning rate for SSB and CW modes, and the scanning steps for the FM-CH function.

When the scanner reaches the edge of the band a beep will sound, and scanning will continue in the same direction from the opposite edge of the band. To manually stop the scanner, press the SCAN DOWN or UP button again momentarily, and to resume scanning, press and hold either button again for 1/2 second.

2. The scanner can be set to stop automatically on either a busy or clear channel by setting the SCAN switch on the top panel to the appropriate position, and the STOP/PAUSE switch to the STOP position. Automatic scanning is started in the same way as manual scanning, and can also be stopped in the same way. For automatic stopping, the scanning system senses the opening of the squelch, so the setting of both the RF GAIN and SQL controls will determine the strength of the signal required to trigger the scanner. In the FM mode, the BUSY SCAN function will stop at the frequency where the discriminator tunes to center (or nearest step).
3. Set the STOP/PAUSE switch to the PAUSE position to activate the automatic scan resume function. The scanner will now halt (and

beep) automatically as above, but the decimals on the display will flicker, and scanning will automatically resume after five seconds. Press the SCAN DOWN, UP or PTT button to stop the automatic scanner. To transmit, release the PTT button and then press it again. To restart the automatic scanner, do the same with the DOWN or UP button.

4. Scanning can also be performed on the memory channels only, regardless of which bands and modes are stored. Press the MR button to call up memory operation, and set the MEMORY selector to the MS position. Start the scanner as described above. If the FM-CH button is pressed, only FM memories will be scanned. Otherwise, all eleven channels will be scanned. If not, check to make sure that the lowest frequency is in channel 0, the next higher in channel 1, and so forth, as some channels may be missed by the memory scanner otherwise. The automatic scan stop features can all be used with memory scanning in the same way as for band scanning.
5. Limited band scanning can also be performed, when only a portion of one band is to be monitored. The upper and lower frequency limits can be programmed by storing the lower limit in one memory channel (0 through 8), and the upper limit in the next higher channel. The mode stored with each frequency need not be the same for both limits, but the mode stored in the lower channel will be that in which the scanner operates. Press the MR button, and set the MEMORY selector to the channel with the lower limit. Press the SCAN DOWN button (or the microphone DWN button) to start the limited scan. If the UP button is used to start limited band scanning, the highest band limit in the next higher channel will not be scanned. Each time a programmed band limit is reached a beep will sound, and scanning will continue at the opposite limit. During limited band scanning, "J" will appear to the left of the operating frequency. Scan stepping and stopping functions are the same as for other scanning methods.

Priority Channel Checking

This feature allows any selected memory to be automatically checked for activity while receiving on a VFO, even if the mode of the VFO is different from that of the priority channel. Before activating this system, while in the memory (MR) function, store in a memory the mode and frequency to be checked. Now with the MEMORY selector set to this channel, press the PRI button. A "P" will appear to the left of the operating frequency, which will be that of the selected VFO (A or B). The mode indicators above the display will also show the mode of the VFO, and every five seconds the displayed frequency and indicators will briefly shift to the stored priority channel data for 1/2 second.

The conditions for stopping the priority checking are the same as for scanning, except that, when these conditions are met, the priority feature will automatically revert to the memory function. A beep will sound, and the memory channel symbol (0 through 9 or C) will appear in place of the "P" on the display. While the priority function is in operation, the VFO may be tuned and the mode changed as usual except that the MW button will be disabled. Also, the MEMORY selector can be rotated to change the channel being checked. If a transmission is made, the priority check will be delayed by five seconds after returning to receive. Priority channel checking can be carried on in any mode, during either simplex, repeater or semi-duplex operation.

Semi-Duplex Operation

While the standard and programmable shifts of the RPT SELECT system can be used for virtually any type of repeater or split-frequency operation on the same band and mode, the VFO A/B system in the FT-726R can also be used for this, while expanding operating capability to cross-band and cross-mode operation as well. Because the memory backup system also retains the independent frequency and mode data in each VFO, they also serve as additional memories.

Set the VFO selector first to position "A", and press the VFO button to enable the VFO functions. Tune this VFO to one of the desired operating frequencies (receive or transmit), and select the desired mode. Now set the VFO selector to position "B", and set up the frequency and mode for the other function (transmit or receive). Switch the VFO selector to either RA-TB (receive on VFO A, transmit on VFO B), or RB-TA (vice-versa). Now the source VFO will be indicated by the symbol ("A" or "B") at the left of the frequency display, and will shift for transmission.

Satellite Operation

When the optional Satellite Unit is installed, full duplex cross-band and cross-mode operation can be performed. The Satellite Unit includes an additional IF system, so that the FT-726R can transmit and receive simultaneously on different bands.

To utilize this feature, tune one VFO (A or B) to the desired transmit band and frequency, and set the RPT SELECT knob to the SIMP position. Tune the other VFO to the receive band (which must be different than that for transmit) and approximate frequency, and set the VFO selector to the appropriate split position (RA-TB or RB-TA). Set the SATELLITE selector to the RX position. Notice that the mode indications above the display now show a mode in both the upper SAT position and the lower NOR position. The upper mode indication is for the transmitting (uplink) VFO, and the lower for the receiver.

When communicating through a satellite transponder, close the PTT switch and use the main knob to tune the receive VFO while transmitting. If the transponder is operating, the retransmission of your signal should be found on the downlink frequency. Note that, if transmitting SSB in one sideband, the downlink signal may be in the opposite sideband. If necessary to check or adjust the transmitting frequency, just set the SATELLITE selector to the TX position, and the display and controls will now function for the transmitting VFO.

During full duplex cross-band operation the parameters indicated by METER I can be selected with the SAT METER selector, as described on page 10. Although it is possible to transmit and receive FM full duplex, this is not used on the amateur satellites at present. Even SSB and CW require either an excellent circular- or cross-polarized antenna or an RF amplifier for the transmitter, and careful attention must be paid to satellite locations and antenna aiming. Please refer to a publication on amateur satellite operation for further details.

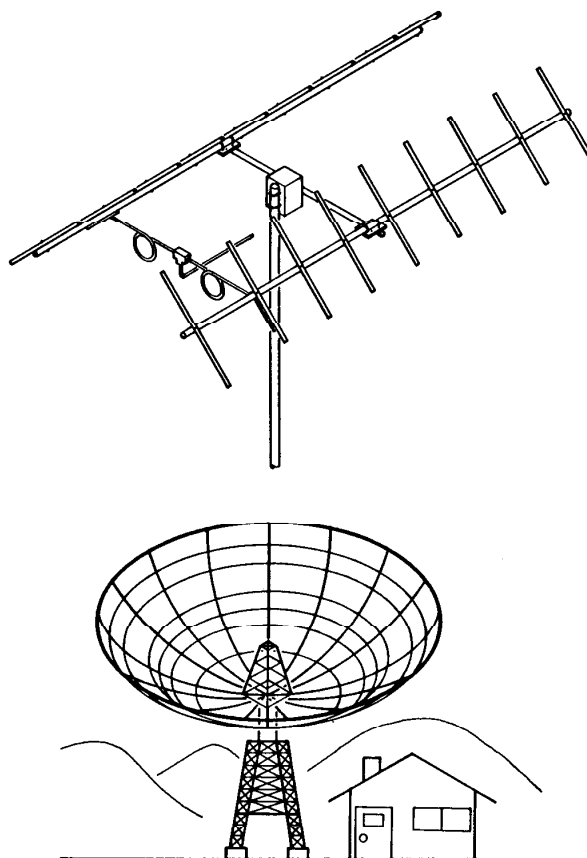

COVER REMOVAL

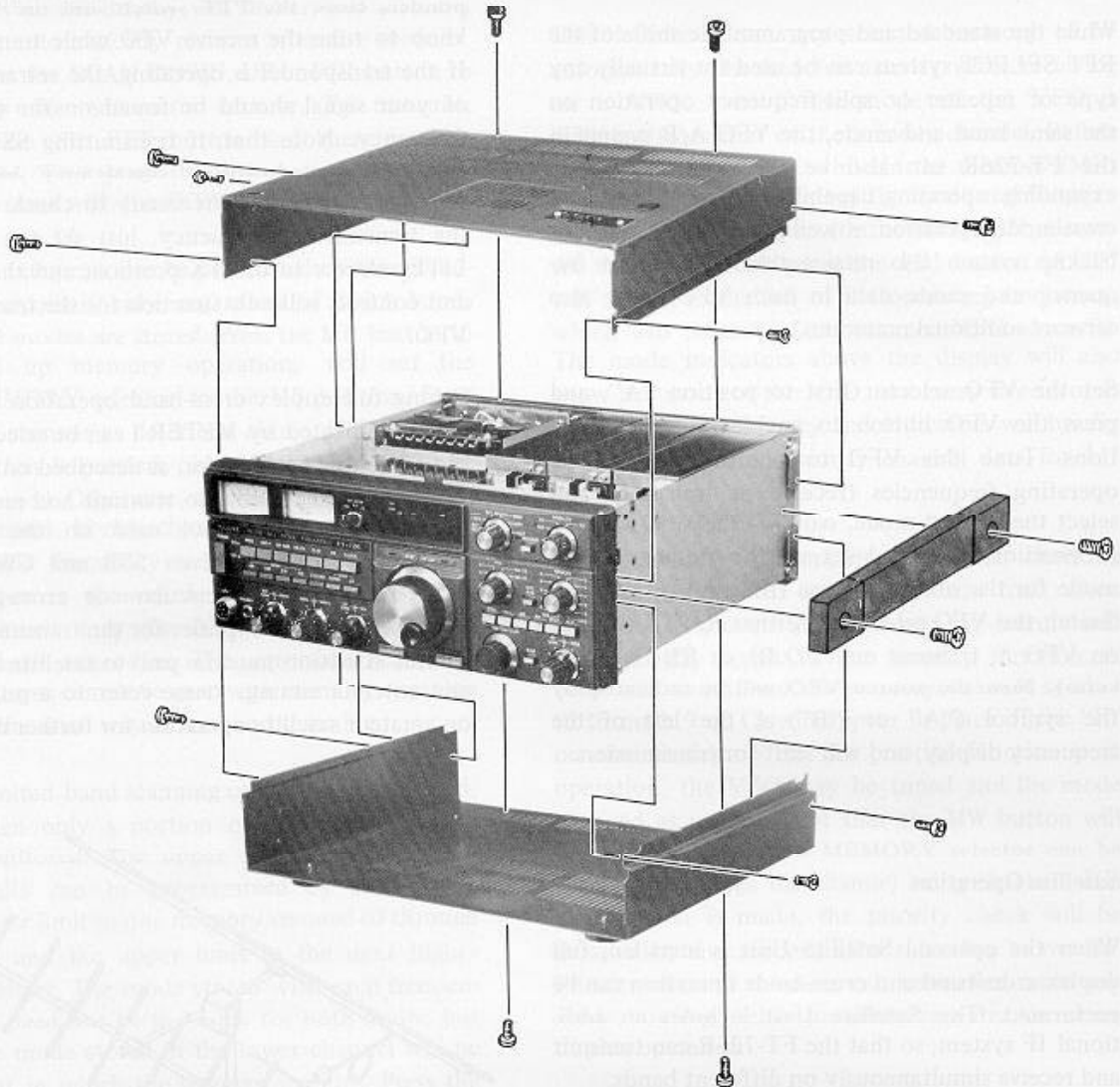

Note:

When removing the top cover, disconnect the cables to the speaker and SCAN/SQL Unit before pulling the cover away. Remember to reconnect these cables when replacing the cover.

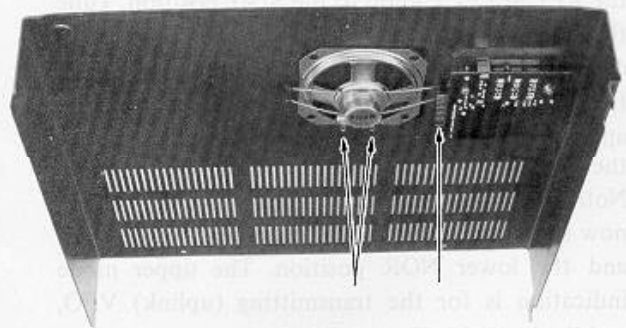

INSTALLATION OF OPTIONS

CW NARROW FILTER

The optional XF-455MC narrow CW filter, kit number D2000034, will provide a 600 Hz maximum IF bandwidth when the CW NAR button is pressed in the CW mode.

1. Remove the two screws affixing the carrying handle, and the seven screws affixing the bottom cover. Remove the handle and cover.
2. Referring to the diagram, locate and remove the four screws marked "★", so as to free the RX Unit for access to the solder side.
3. Install the filter in the location illustrated, and carefully solder the four filter terminals on the solder side of the RX Unit, while holding the filter snugly against the board on the component side. Trim off any excess from these terminal wires.
4. Referring to the drawing below, locate jumper plug P₂₀₀₁, installed in J₂₀₁₂. Remove P₂₀₀₁ and reinstall it in the opposite direction (180°) from its original position in J₂₀₁₂. The two pins which are jumpered should now be the two nearest the filter.
5. Replace the RX Unit and its four screws, using care to avoid pinching or stressing connecting wires. Then replace the bottom cover and its seven screws, and the carrying handle and its two screws. This completes the installation.

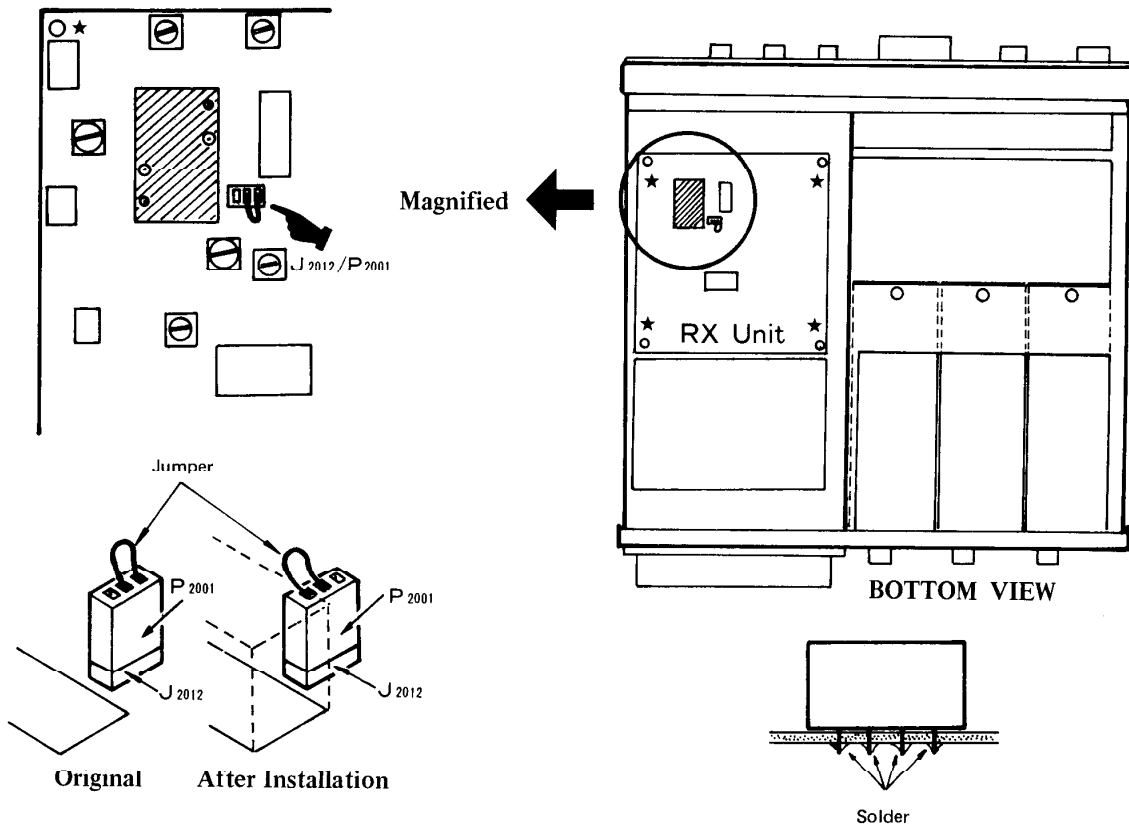

BAND MODULES

Up to three Band Modules may be installed in the FT-726R simultaneously, using appropriate Kits, the numbers of which are listed on page 3. Each Kit contains the Module plus the following parts:

- 11-pin connection cable (on J₅₀₀₂ in the Module)
- 5-pin connection cable (on J₆₀₀₃ in the Module)
- 12-pin connection cable (on J₆₀₀₄ in the Module)
- one M3 x 6 screw
- four M2.6 x 8 screws

Installation

1. Disconnect the transceiver from the power source.
2. Referring to the photo on page 26, remove the two carrying handle screws and the twelve screws affixing the top and bottom covers. Remove the top cover carefully, disconnecting the speaker and SCAN/SQL cables before pulling the cover away. Then remove the bottom cover.
3. Select the mounting position for the band to be installed. Any vacant position may be used, except that 430 and 440 MHz Units must not be installed in the position nearest the power transformer, as the magnetic flux may interfere with operation of these units.

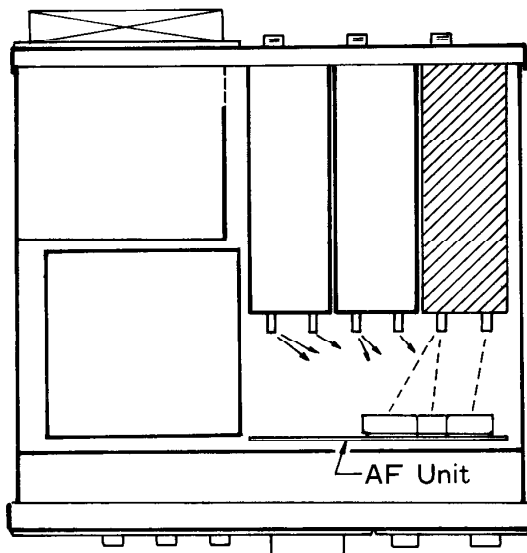

TOP VIEW

4. Set the Module in its mounting position from the top, with the antenna jack towards the bottom so that it fits through the hole in the rear panel. Affix the module with the short screw through the bottom chassis plate, and the four screws through the rear panel.
5. Connect the free ends of the three connection cables to the appropriate jacks on the AF Unit, as indicated below. Note that the lowest set of jacks, J₃₀₀₇, J₃₀₀₈ and J₃₀₀₉, are in the default position, meaning that the module connected here will be the one activated when the memory backup system is off, or unprogrammed, when power is first applied. Otherwise, any module may be connected to any of the three sets of jacks, though they must all be in the same line. Check all cable connections carefully.
6. Replace the top and bottom covers and their twelve screws, and the carrying handle and its two screws.

Installation is now complete. No alignment is required, as all Modules are completely aligned and tested at the factory.

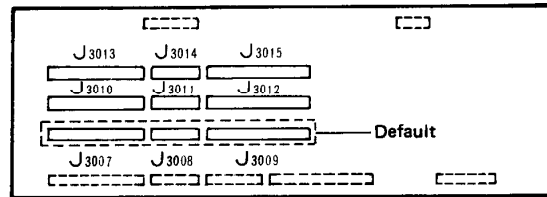

AF Unit

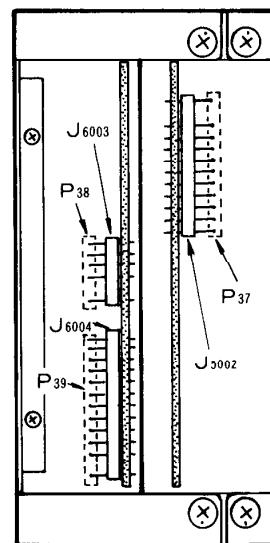

Module

SATELLITE UNIT

Kit number D3000235 includes the SAT Unit and four M3 x 6 screws.

Installation

- Referring to the diagram on page 26, remove the seven screws affixing the top cover and the two carrying handle screws. Lift the cover slowly, just enough to disconnect the cables to the speaker and SCAN/SQL Unit, before lifting the cover away.
- In the front lefthand corner of the transceiver, locate the TX Unit, as shown in the photo on page 32. Now referring to the diagram below, locate plugs P_{25} and P_{29} taped to the TX Unit (illustrated with dotted lines below). Also locate plugs P_{27} , P_{30} and P_{205} taped to the inner chassis shield, and P_{28} taped to the left side chassis (also illustrated with dotted lines).
- Remove the top shield cover from the SAT Unit, and position it over the TX Unit so that the "Ser No." label is at the right front edge, as shown below.
- Remove P_{25} and P_{29} from the TX Unit, and route the cables through Cutout C, connecting the plugs to J_{4005} and J_{4001} on the SAT Unit, as indicated below. Remove P_{27} , P_{30} and P_{205} from the shield, and route the cables through Cutout B, connecting the plugs to J_{4002} , J_{4004} and J_{4003} on the SAT Unit. Remove P_{28} from the side chassis and route through Cutout A to J_{4006} .
- Using the four screws supplied with the kit, affix the SAT Unit to the four spacers projecting from the TX Unit. Make sure that no wires are pinched or stressed, and replace the SAT Unit shield cover so that the label on the shield cover is toward the front of the transceiver.
- Replace the speaker and SCAN SQL cables, and the top cover and carrying handle, and their screws. This completes the installation.

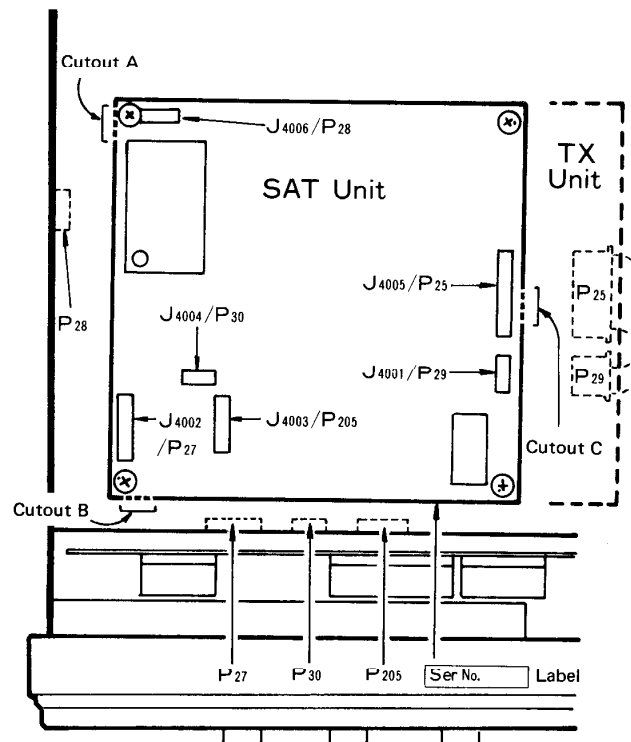

TONE UNITS

The following procedure applies for installation of the FTS-32R Tone Squelch Unit or the FTE-36 Tone Encoder Unit, providing, respectively, 32 or 31 subaudible (CTCSS) DIP switch programmable tones. The FTS-32R installation requires Kit no. D3000205, and the FTE-36, Kit no. D3000203. The following procedure is not intended for the US model FT-726R.

Installation

1. Referring to the diagram on page 26, remove the seven screws affixing the top cover and the two carrying handle screws. Lift the cover slowly, just enough to disconnect the cables to the speaker and SCAN/SQL Unit, before lifting the cover away.
2. Referring to the photos on the next page, remove the two screws affixing the SCAN/SQL Unit on the top cover, and remove the Unit.
3. Connect P₀₁ from the SCAN/SQL Unit to jack J₁ on the Tone Unit, as indicated in the diagrams at the right. Then use the double-sided adhesive tape to mount the Tone Unit precisely over the outlined area on the SCAN/SQL Unit, so that the DIP switch is toward the right rear corner as shown in the photos.
4. Replace the SCAN/SQL Unit and its two screws, and reconnect the SCAN/SQL and speaker cables before replacing the top cover and carrying handle, and their screws.
5. Referring to the tone frequency programming tables supplied with the Kit, set the DIP switches for the desired tone frequency (accessing the DIP switches through the rectangular rubber plug on the top cover of the transceiver).
6. Replace the rubber plug after programming or changing the tone frequency, so as to keep dust from accumulating.

To activate the Tone Unit, set the T. SQ switch on the top panel to ON.

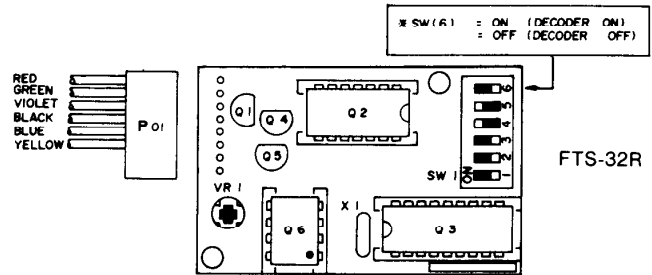

88.5 Hz	SW No.	1	2	3	4	5	6	88.5 Hz
	ON/OFF	1	1	1	0	0	X	
		CLOSED = 0 (ON)						
		OPEN = 1 (OFF)						

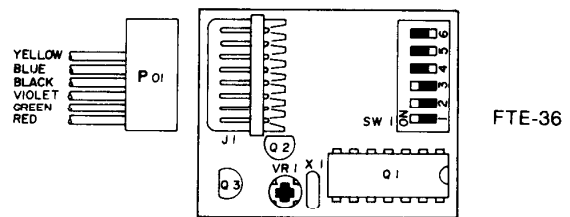

88.5 Hz	SW No.	1	2	3	4	5	6	88.5 Hz
	ON/OFF	0	0	0	1	1	1	
		CLOSED = 0 (ON)						
		OPEN = 1 (OFF)						

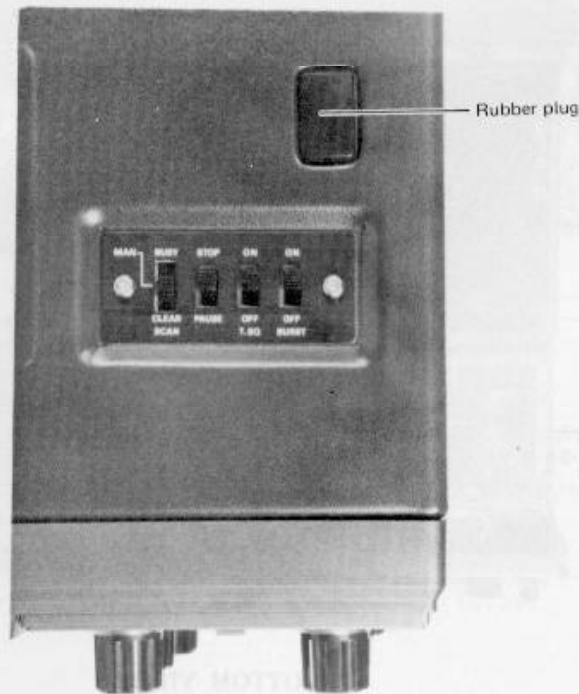
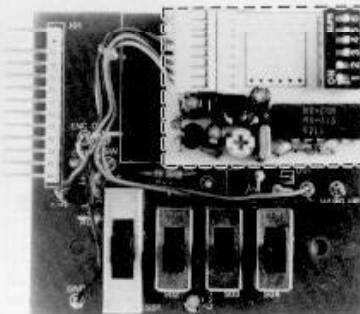
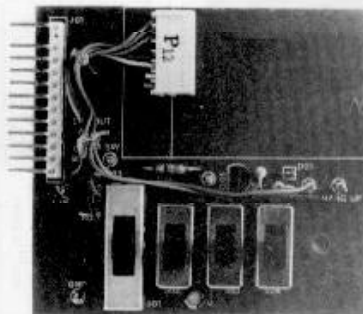
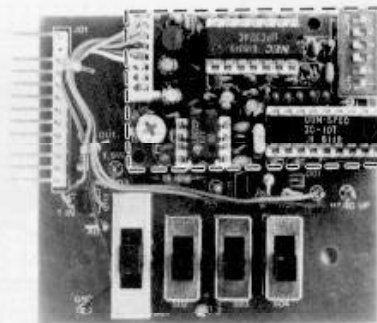
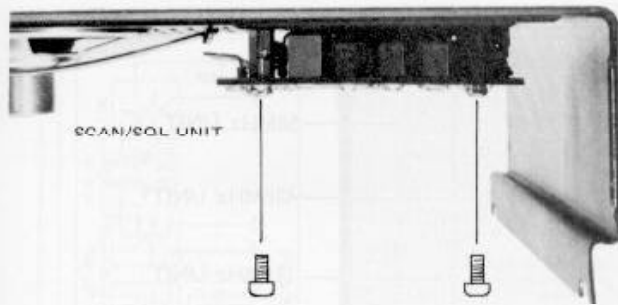

LINE UNITS

The following information applies to the following
the PNR-1234. Your equipment may not be identical.

From the following information, you can determine the
the following information.

1. The following information is for the following
the following information.

2. The following information is for the following
the following information.

3. The following information is for the following
the following information.

4. The following information is for the following
the following information.

5. The following information is for the following
the following information.

6. The following information is for the following
the following information.

7. The following information is for the following
the following information.

8. The following information is for the following
the following information.

9. The following information is for the following
the following information.

10. The following information is for the following
the following information.

11. The following information is for the following
the following information.

12. The following information is for the following
the following information.

13. The following information is for the following
the following information.

14. The following information is for the following
the following information.

15. The following information is for the following
the following information.

16. The following information is for the following
the following information.

17. The following information is for the following
the following information.

18. The following information is for the following
the following information.

19. The following information is for the following
the following information.

20. The following information is for the following
the following information.

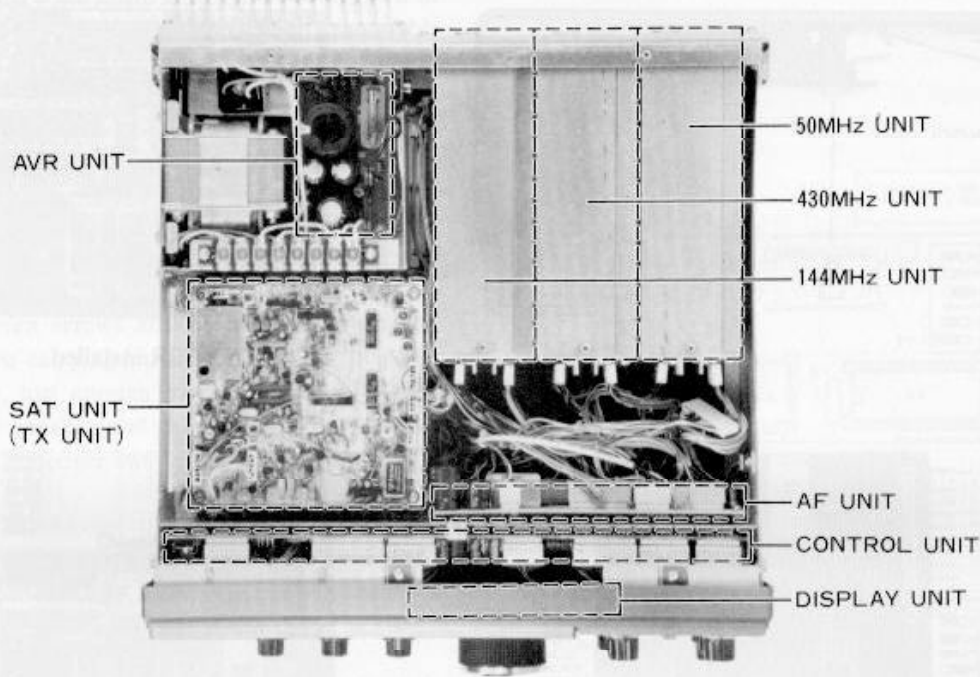

TOP VIEW

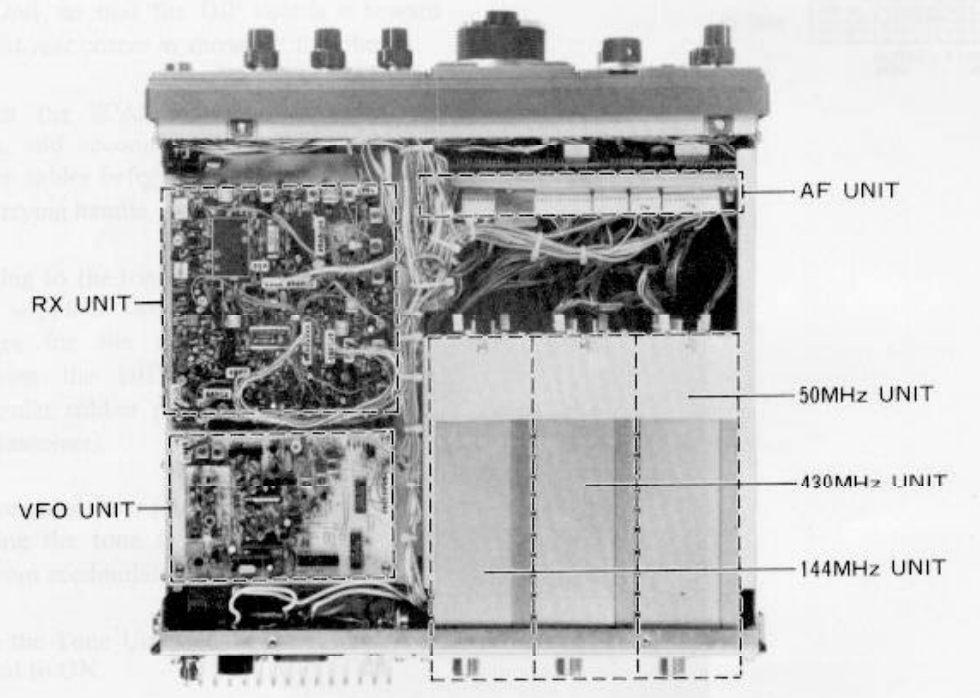

BOTTOM VIEW

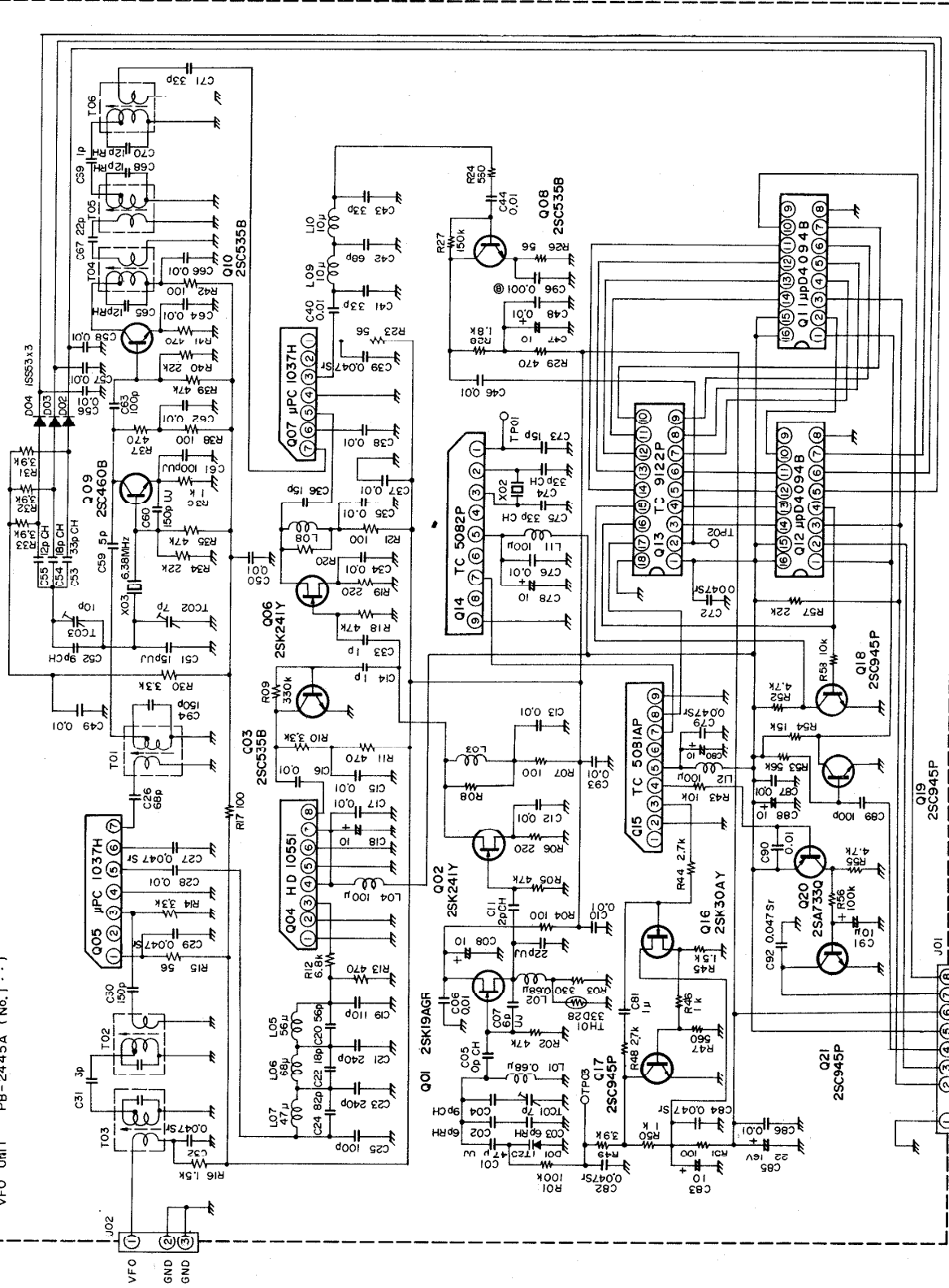

RESISTOR VALUES ARE IN Ω , 1/4W. CAPACITOR VALUES ARE IN μ F, 50V AND INDUCTOR VALUES ARE IN HENRIES, UNLESS OTHERWISE NOTED
 ELECTROLYTIC CAPACITOR VALUES ARE IN μ F, 16V UNLESS OTHERWISE NOTED
 DIODES ARE TYPE 1SS53 UNLESS OTHERWISE NOTED

DATA 0
 SAT BV
 5V
 S STR
 DATA
 CLOCK
 J01 (1)(2)(3)(4)(5)(6)(7)(8)

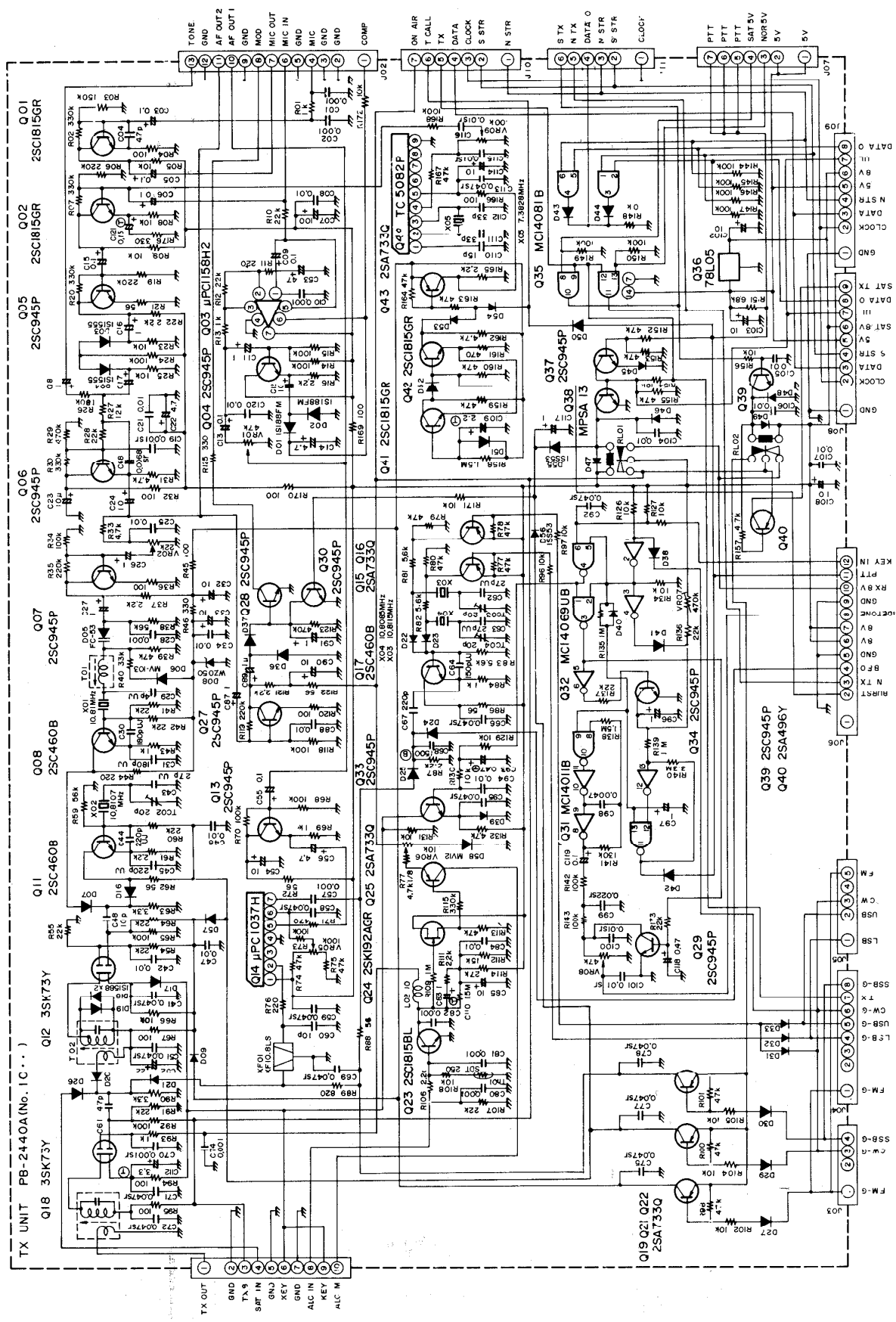

RESISTOR VALUES ARE IN Ω , 1/4W. CAPACITOR VALUES ARE IN μ F, 50V AND INDUCTOR VALUES ARE IN HENRIES, UNLESS OTHERWISE NOTED
 ELECTROLYTIC CAPACITOR VALUES ARE IN μ F, 15WV UNLESS OTHERWISE NOTED
 DIODES ARE TYPE 1SS53 UNLESS OTHERWISE NOTED

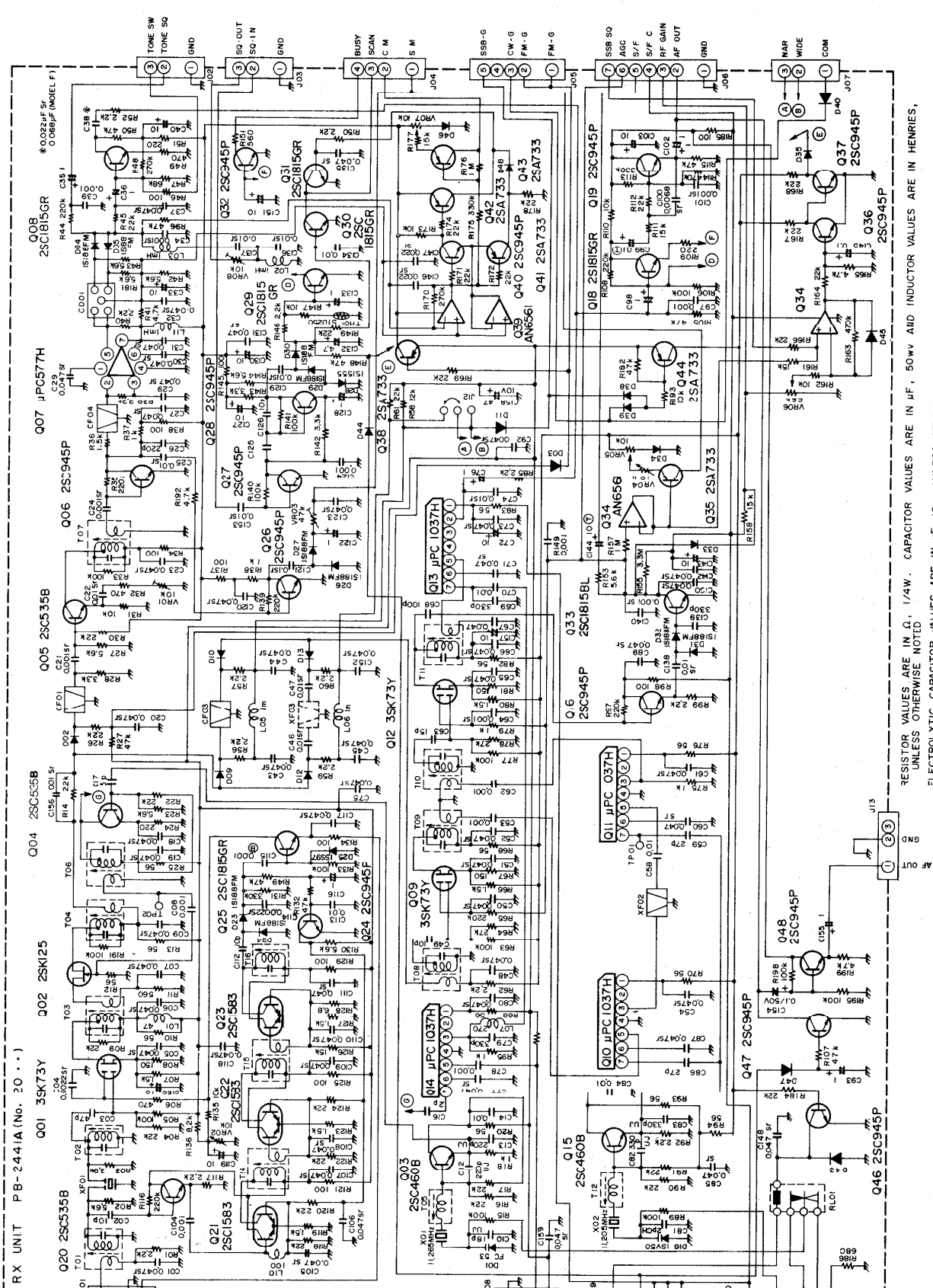

RESISTOR VALUES ARE IN Ω, 1/4W. CAPACITOR VALUES ARE IN μF, 50wV AND INDUCTOR VALUES ARE IN HENRIES, UNLESS OTHERWISE NOTED.
ELECTROLYTIC CAPACITOR VALUES ARE IN μF, 16V, UNLESS OTHERWISE NOTED.
DIODES ARE TYPE 1S553 UNLESS OTHERWISE NOTED.

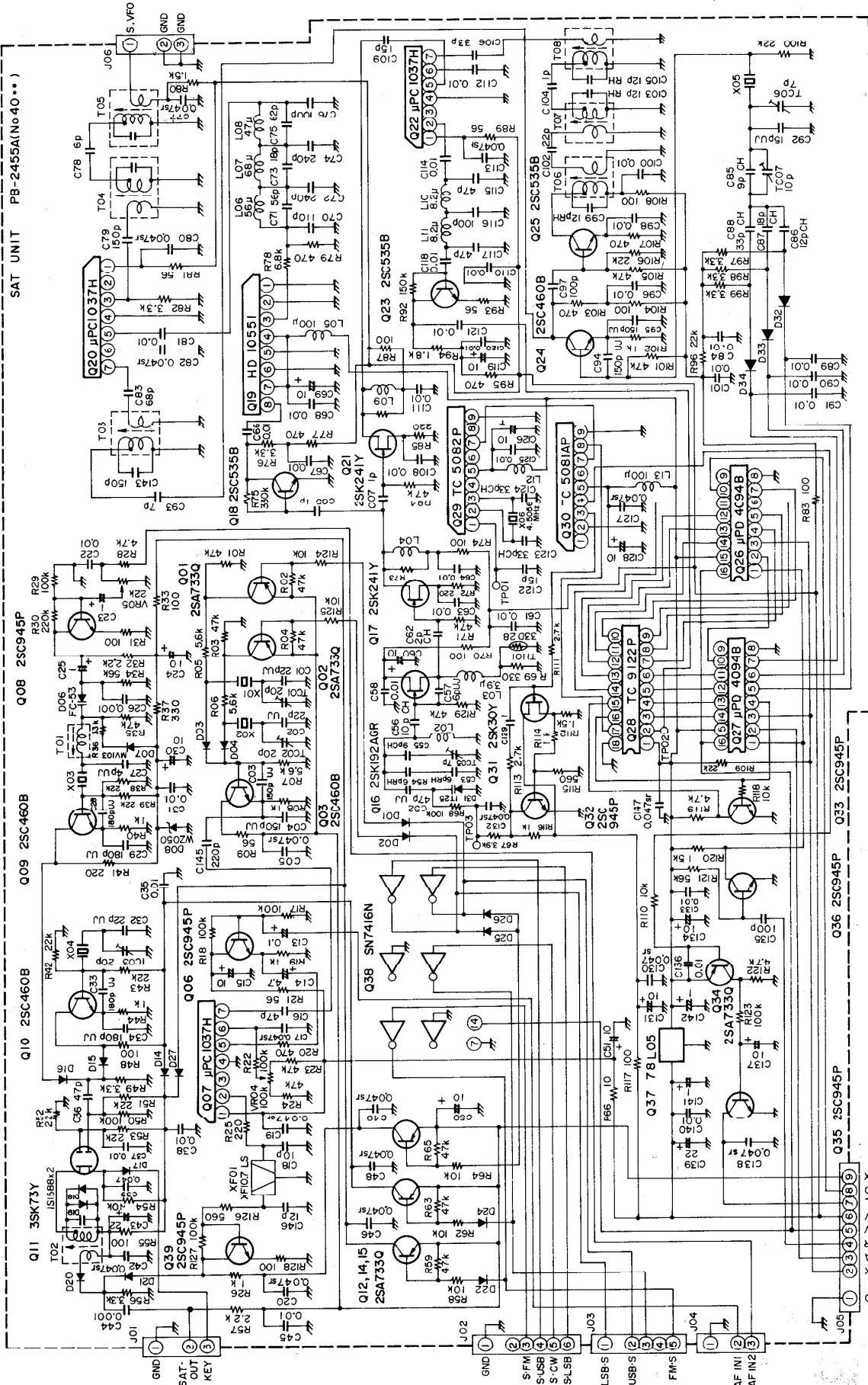

RESISTOR VALUES ARE IN Ω , 1/ μ W.
 CAPACITOR VALUES ARE IN μ F, 50WV AND
 UNLESS OTHERWISE NOTED.
 INDUCTOR VALUES ARE IN HENRIES,
 UNLESS OTHERWISE NOTED.
 ELECTROLYTIC CAPACITOR VALUES ARE
 IN μ F, 16WV UNLESS OTHERWISE NOTED.
 DIODES ARE TYPE 1SS53 UNLESS OTHERWISE NOTED.

DATA - TX
 C-L
 SAT-8V
 5V
 S-STR
 DATA
 CLOCK
 GND

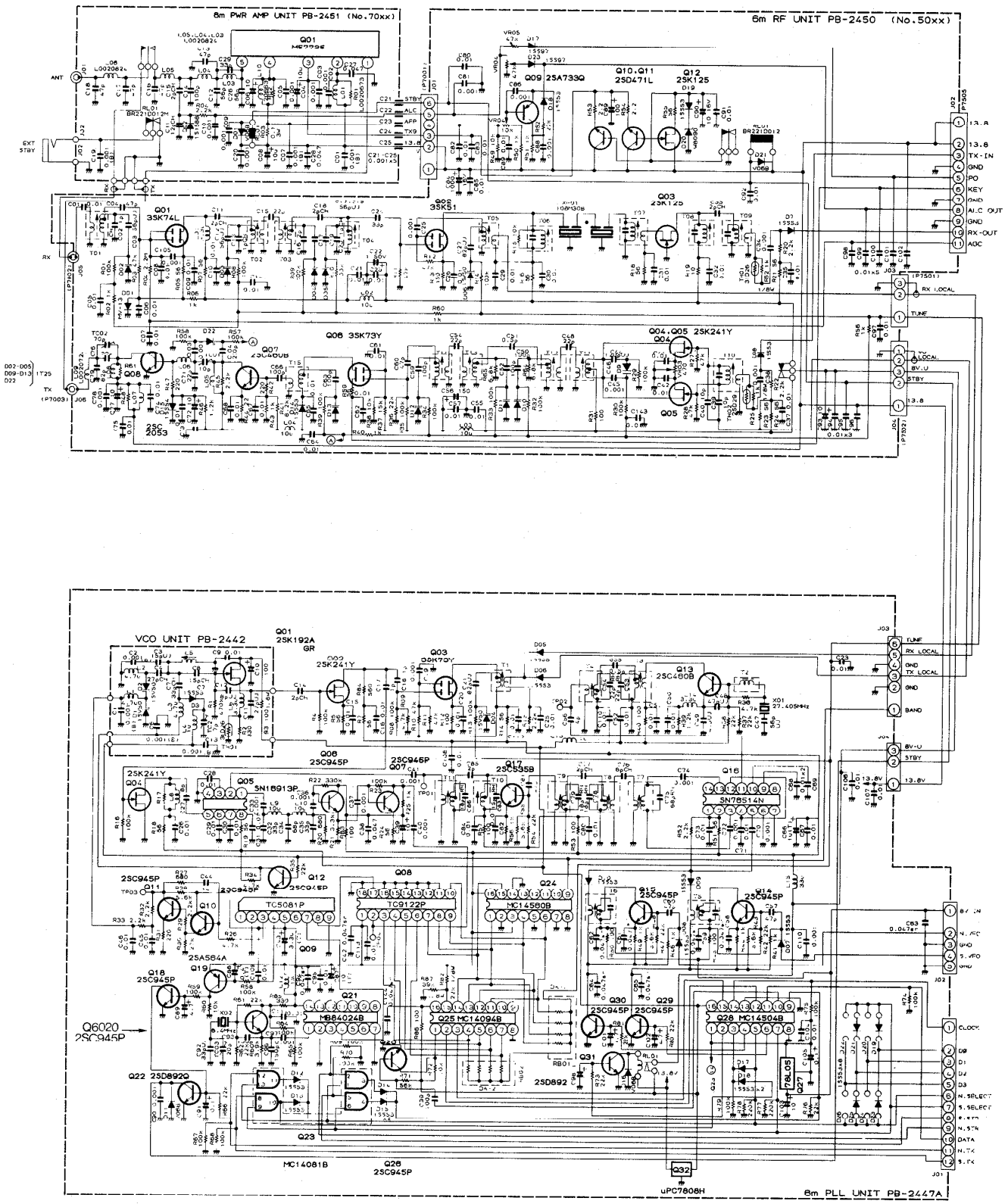

	B	A
X	D5019	X

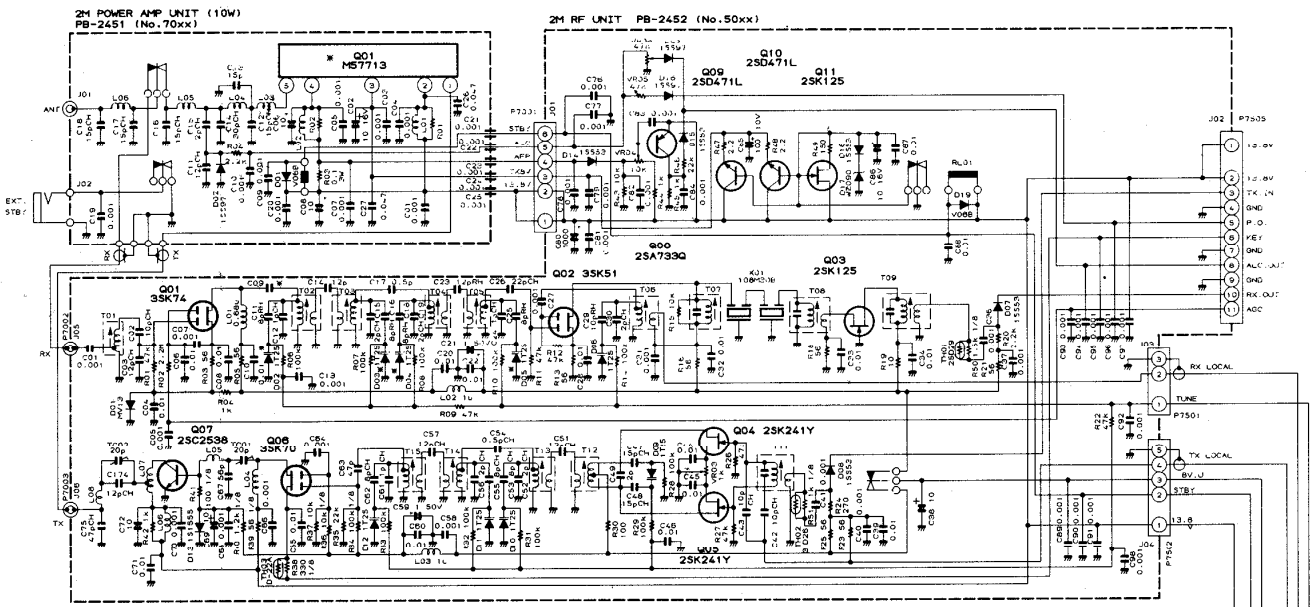

	JAPAN	EXPORT
D02	1B2CH(C99)	1T25
D03	1X2CH(C100)	1T25
D04	1Z2CH(C101)	1T25
D05	1Z2CH(C102)	1T25
C09	3uCh	4uCh

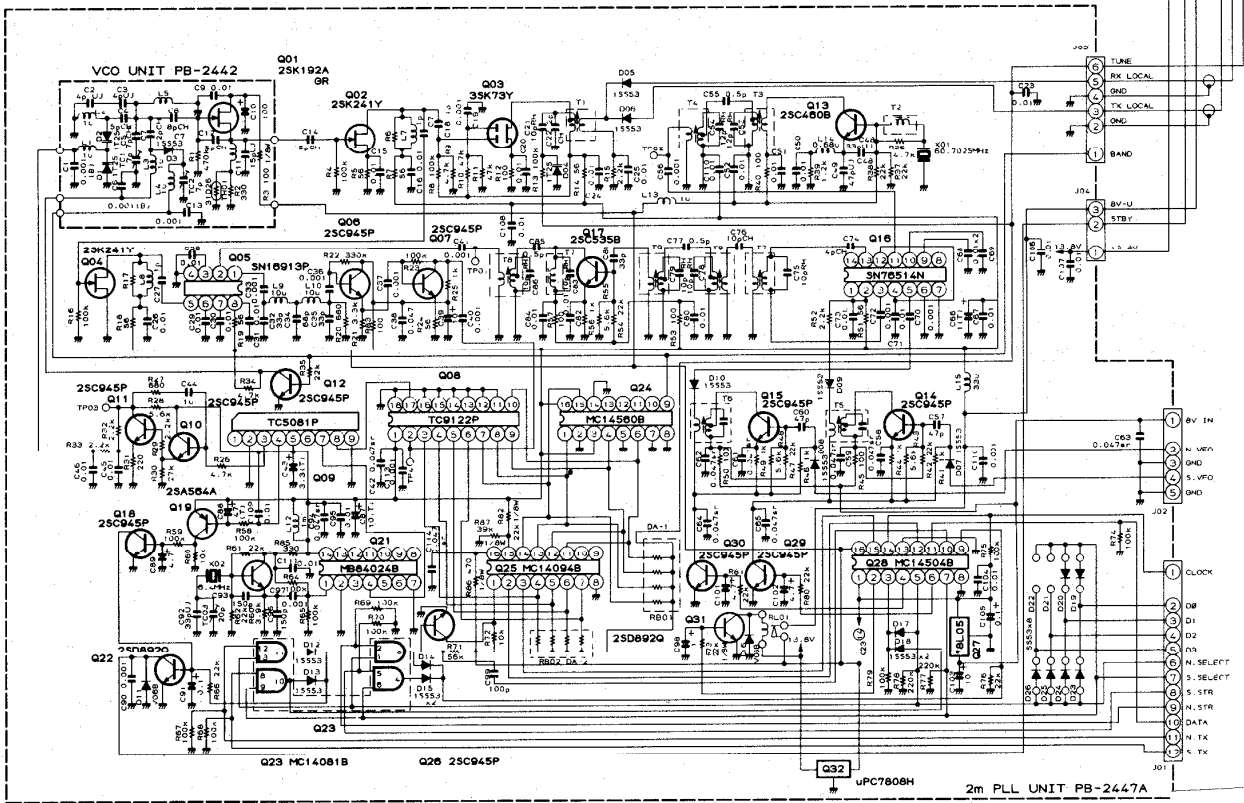

	F	A	A	B	C	D	E
D19	X	X	X	X	X	X	X
D20	X	X	X	X	X	X	X
D21	X	X	X	X	X	X	X
D22	X	X	X	X	X	X	X
D23	X	X	X	X	X	X	X
D24	X	X	X	X	X	X	X
D25	X	X	X	X	X	X	X
D26	X	X	X	X	X	X	X
RB02	X	X	X	X	X	X	X

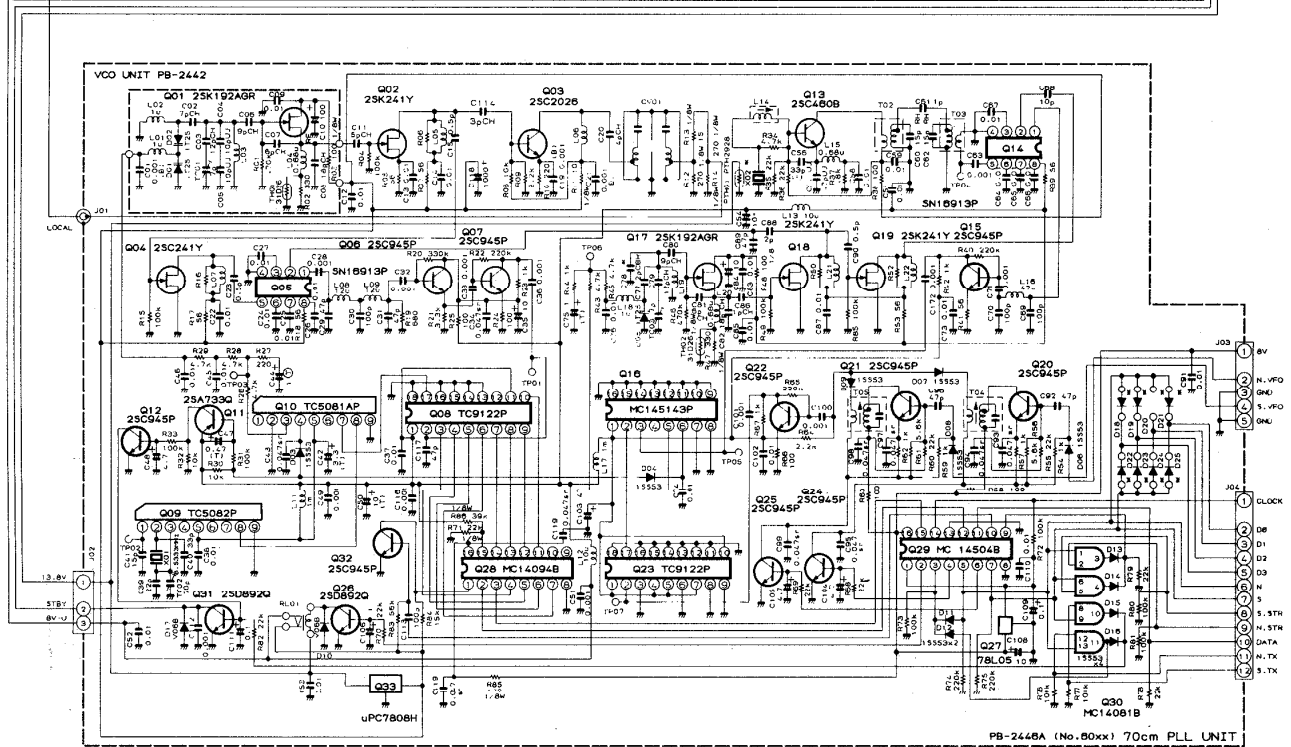
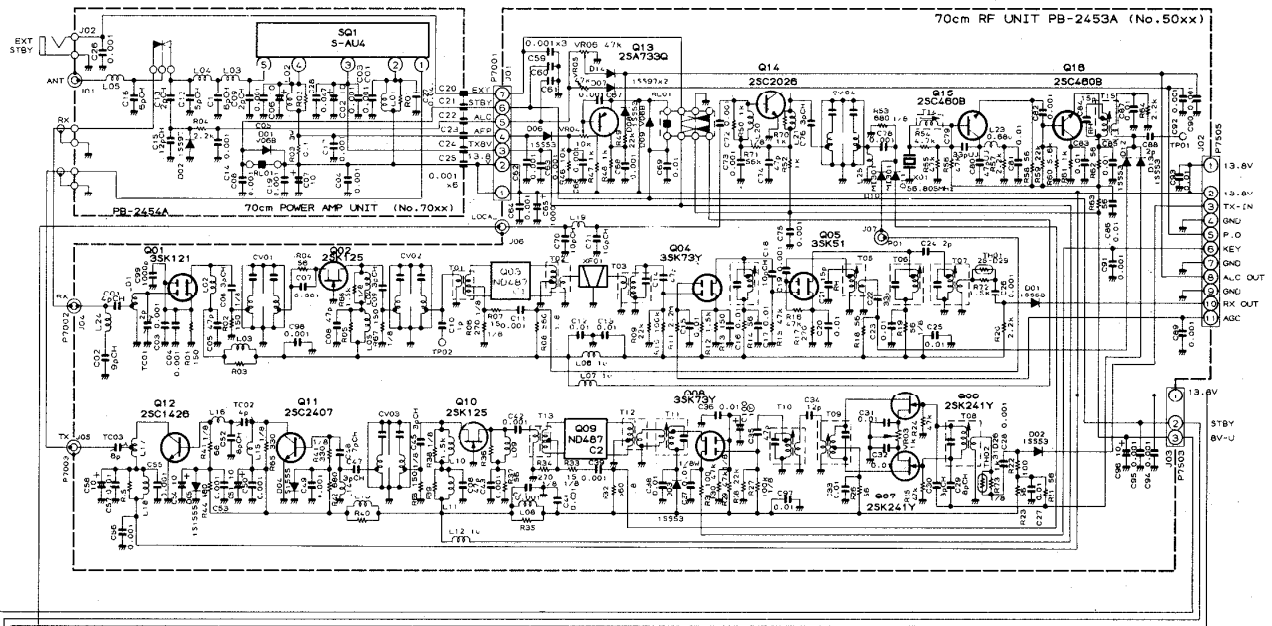

D6016		A	X	S	L
D6019		O	O	O	O
D6020	X	X	X	X	X
D6021	X	X	O	X	X
D6022		O	O	O	O
D6023	X	O	O	O	X
D6024		O	X	O	X
D6025	O	X	X	O	O

	F	B	C
X6002	57.4333	57.4333	57.1000
C6076	8pRn	8pRn	7pRn
			8pRn
			8pRn

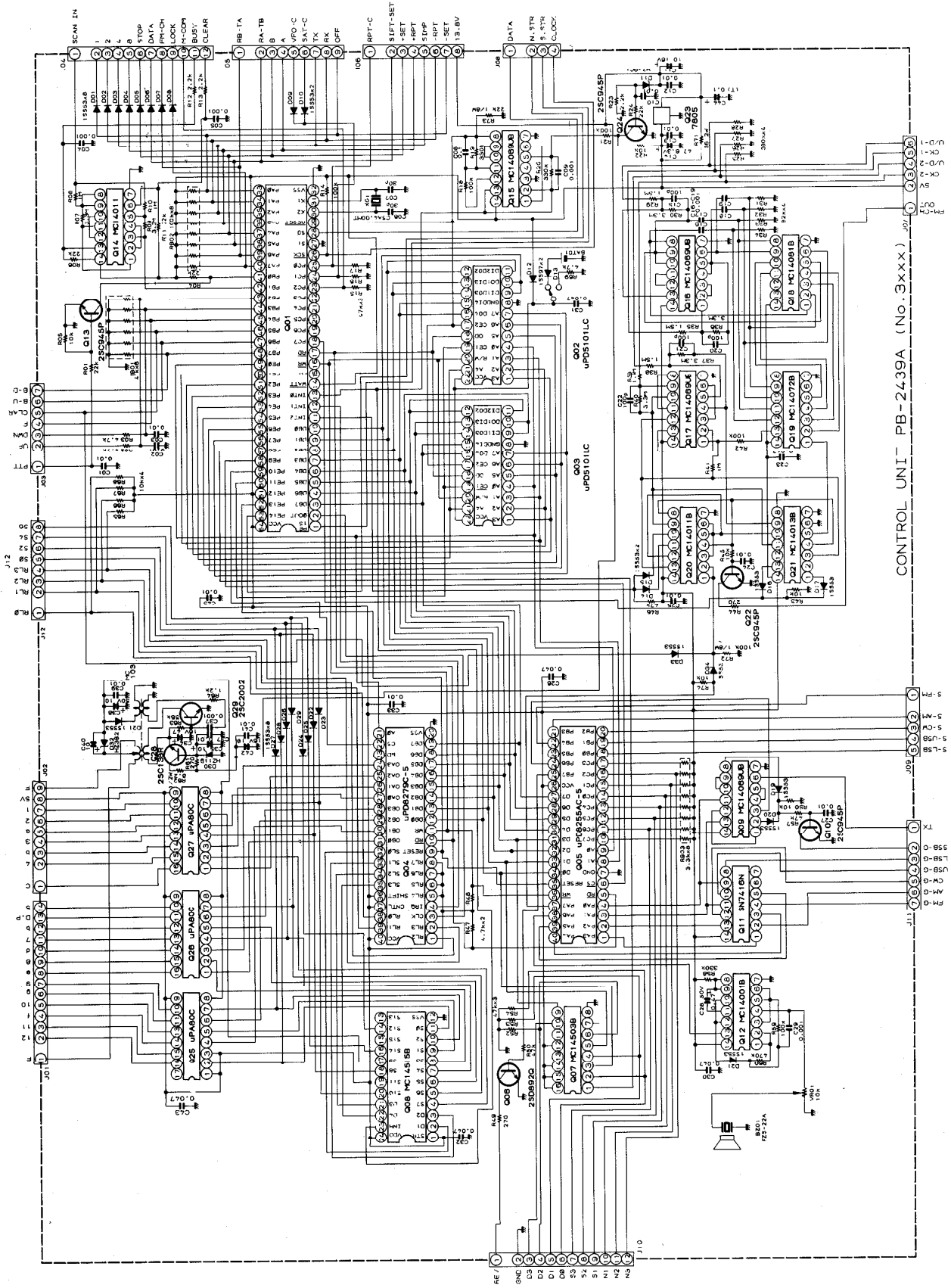

CONTROL UNIT PB-2439A (No. 3xxx)

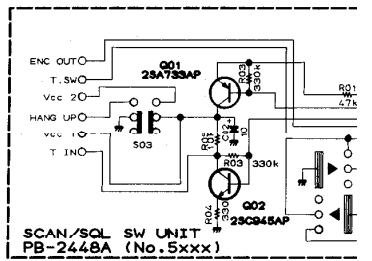
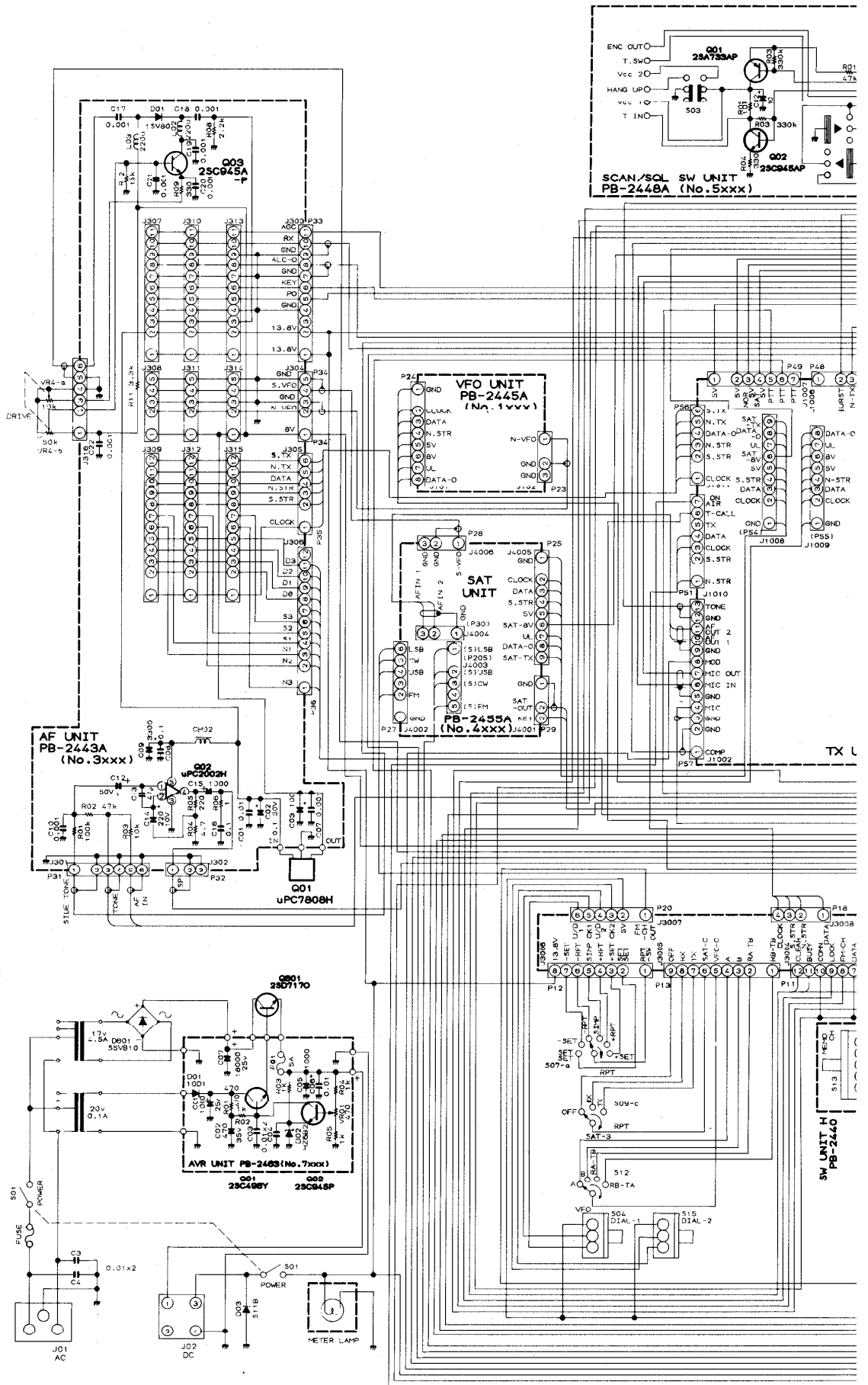

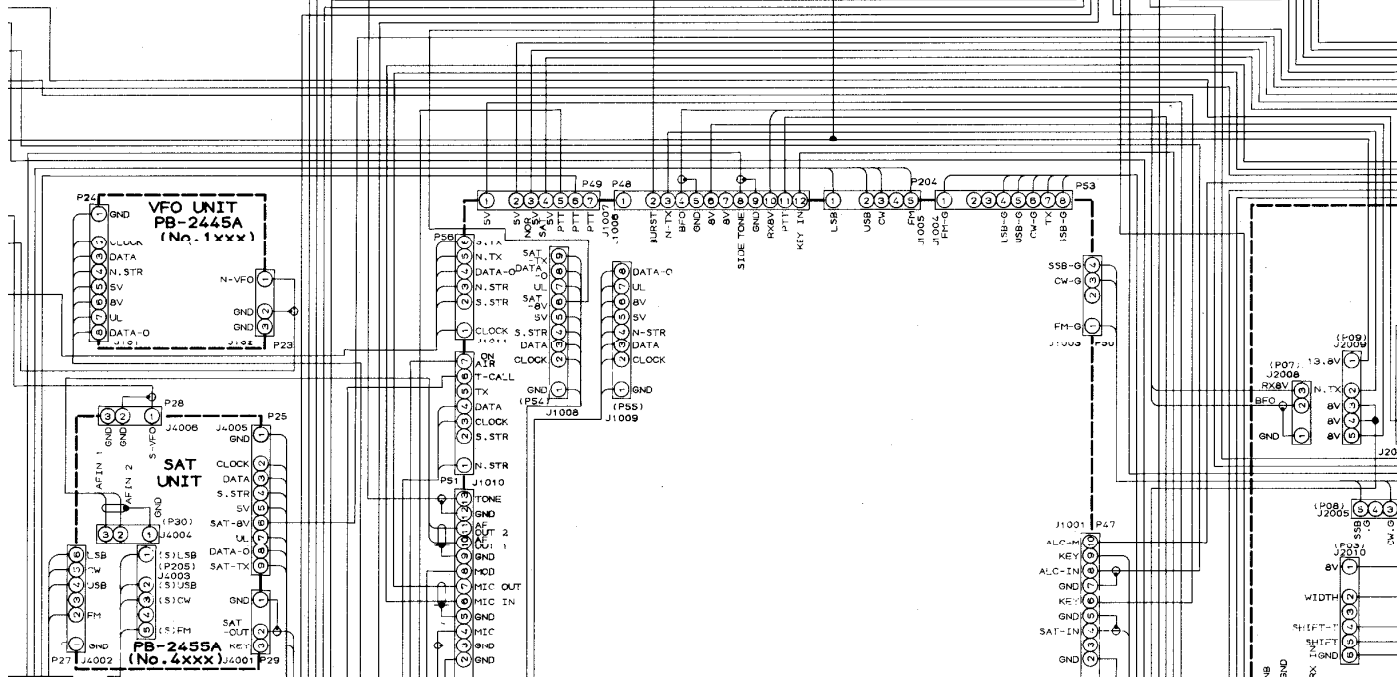
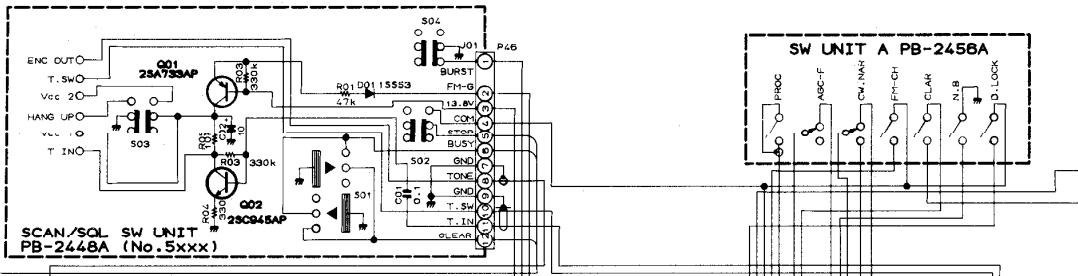

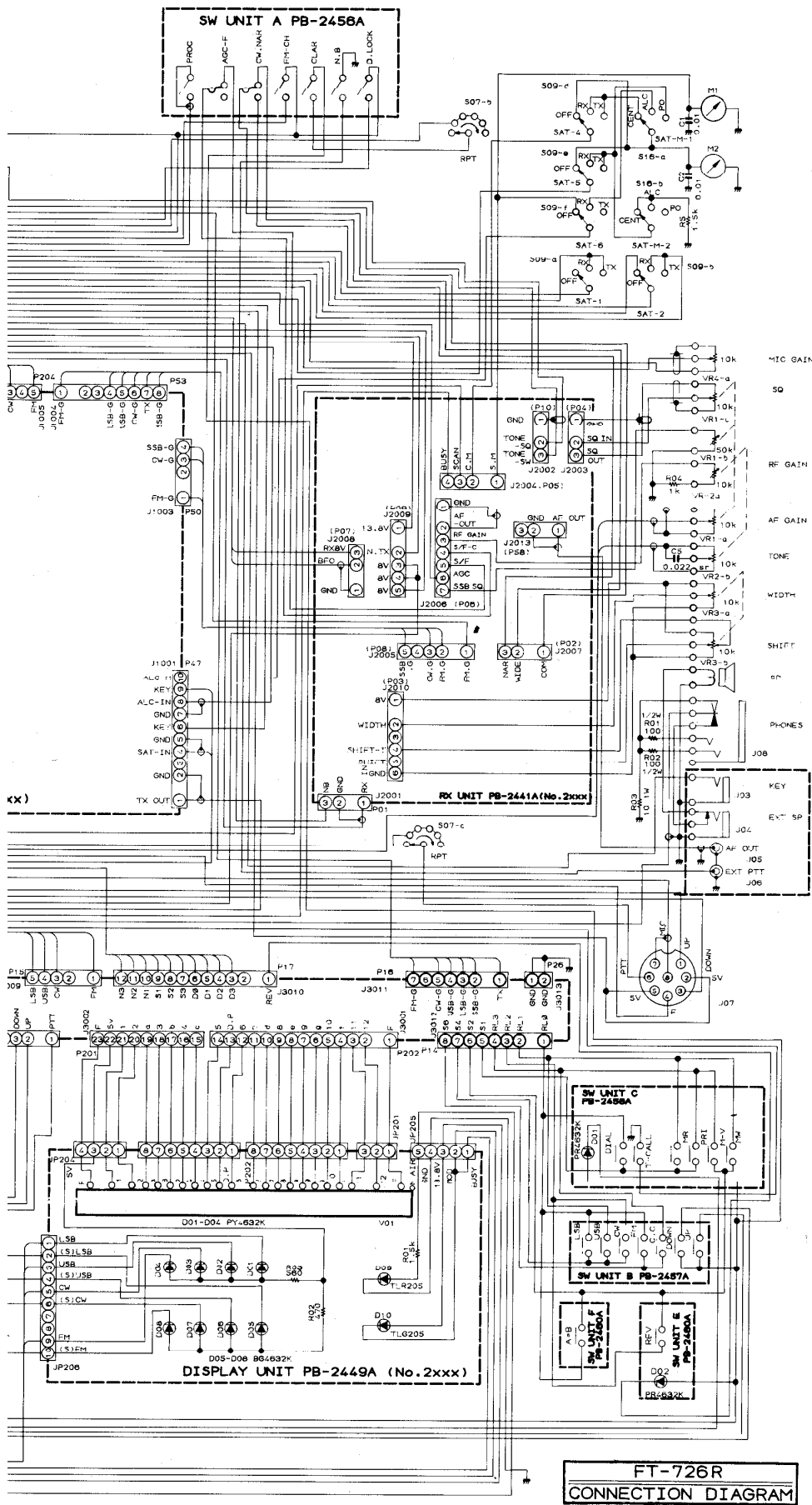



E3830183A(B307-D)